

# Panasonic®

## Operating Instructions High Definition Plasma Television Manual de instrucciones Televisor de plasma de alta definición

Model No.  
Número de modelo **TH-42PZ700U**  
**TH-50PZ700U**  
**TH-58PZ700U**



### Quick Start Guide

(See page 6)

### Guía de inicio rápido

(vea la página 6)



- For assistance (U.S.A.), please call:  
**1-888-VIEW-PTV (843-9788)**  
or visit us at [www.panasonic.com/contactinfo](http://www.panasonic.com/contactinfo)
- For assistance (Puerto Rico), please call:  
**787-750-4300**  
or visit us at [www.panasonic.com](http://www.panasonic.com)
- For assistance (Canada), please call:  
**1-800-561-5505**  
or visit us at [www.panasonic.ca](http://www.panasonic.ca)
- Para solicitar ayuda (EE.UU.), llame al:  
**1-888-VIEW-PTV (843-9788)**  
ó visítenos en [www.panasonic.com/contactinfo](http://www.panasonic.com/contactinfo)
- Para solicitar ayuda (Puerto Rico), llame al:  
**787-750-4300**  
ó visítenos en [www.panasonic.com](http://www.panasonic.com)

**HDMI™**  
HIGH-DEFINITION MULTIMEDIA INTERFACE

**HDTV**

**BBE®**  
High Definition Sound

**BBE.ViVA**  
HD3D Sound

**SD**  
**CG**

**English**

Please read these instructions before operating your set and retain them for future reference.  
The images shown in this manual are for illustrative purposes only.



**Español**

Lea estas instrucciones antes de utilizar su televisor y guárdelas para consultarlas en el futuro.  
Las imágenes mostradas en este manual tienen solamente fines ilustrativos.

TQB2AA0761-1

Turn your own living room into a movie theater!  
**Experience an amazing level of multimedia excitement**



 <p>SDHC Logo is a trademark.</p>	 <p>GalleryPlayer®</p> <p>GalleryPlayer and the GalleryPlayer Logo are trademarks of GalleryPlayer, Inc.</p>	<p><b>BBE.ViVA</b>          HD3D Sound</p> <p>Manufactured under license from BBE Sound, Inc.</p> <p><b>BBE</b>®          High Definition Sound</p> <p>Licensed by BBE Sound, Inc. under one or more of the following US patents: 5510752, 5736897.          BBE and BBE symbol are registered trademarks of BBE Sound, Inc.</p>
<p><b>HDMI</b>™  <small>HIGH-DEFINITION MULTIMEDIA INTERFACE</small></p> <p>HDMI, the HDMI logo and High-Definition Multimedia Interface are trademarks or registered trademarks of HDMI Licensing LLC.</p>		

# Contents

## Please read before using the unit

- Safety Precautions..... 4
- Notes..... 5

## Quick Start Guide

- Accessories/Optional Accessory ... 6
- To Prevent TV from Falling Over ... 8
- Before Connection ..... 10
- Basic Connection ..... 11
- Identifying Controls ..... 17
- First Time Setup ..... 18

## Enjoy your TV!

### Basic Features

- Watching TV..... 20
- Viewing from SD Card ..... 22
- Watching Videos and DVDs..... 24
- Displaying PC Screen on TV ..... 26



### Advanced Features

- How to Use Menu Functions  
(picture, sound quality, etc.) ..... 28
- EZ Sync™ “HDAVI Control™”..... 32
- Lock ..... 34
- Editing and Setting Channels ..... 36
- Input Labels/Monitor Out/Closed Caption..... 38
- Using Timer..... 40
- Operating Peripheral Equipment ..... 41
- Recommended AV Connections ..... 42

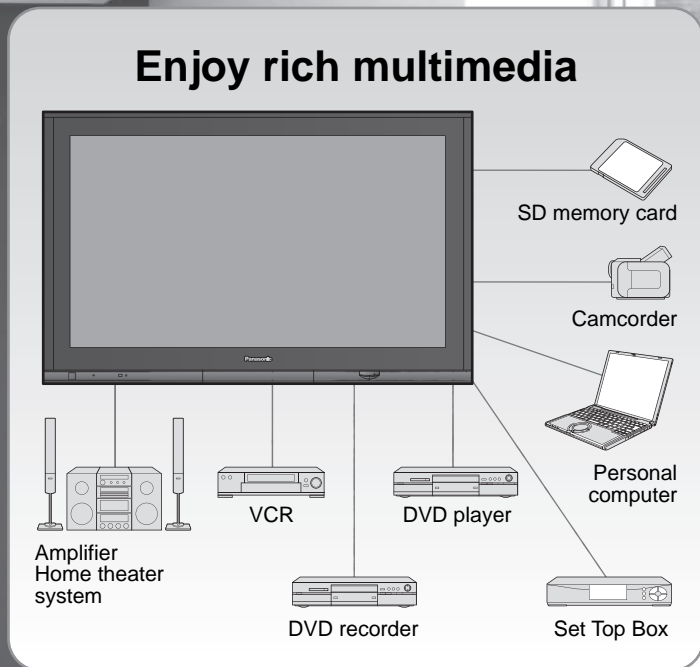

### FAQs, etc.

- Remote Control Operation/Code List..... 44
- Ratings List for Lock ..... 48
- Maintenance ..... 49
- Technical Information ..... 50
- FAQ..... 54
- Specifications..... 56
- Limited Warranty (for U.S.A.)..... 57
- Customer Services Directory (for U. S. A.).... 58
- Limited Warranty (for Canada)..... 59

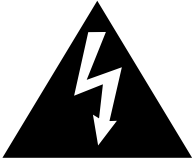

<p><b>EZ Sync™</b></p> <p>EZ Sync™ is a trademark of Matsushita Electric Industrial Co., Ltd.</p>	
<p><b>HDAVI Control™</b></p> <p>HDAVI Control™ is a trademark of Matsushita Electric Industrial Co., Ltd.</p>	
<p>Manufactured under license from Dolby Laboratories. DOLBY and the double-D symbol are trademarks of Dolby Laboratories.</p>	

# Safety Precautions

	<b>CAUTION</b> <b>RISK OF ELECTRIC SHOCK</b> <b>DO NOT OPEN</b>	
<b>WARNING: To reduce the risk of electric shock, do not remove cover or back. No user-serviceable parts inside. Refer servicing to qualified service personnel.</b>		



The lightning flash with arrowhead within a triangle is intended to tell the user that parts inside the product are a risk of electric shock to persons.



The exclamation point within a triangle is intended to tell the user that important operating and servicing instructions are in the papers with the appliance.

**WARNING:** To reduce the risk of fire or electric shock, do not expose this apparatus to rain or moisture. Do not place liquid containers (flower vase, cups, cosmetics, etc.) above the set (including on shelves above, etc.).

## Important Safety Instructions

- 1) Read these instructions.
- 2) Keep these instructions.
- 3) Heed all warnings.
- 4) Follow all instructions.
- 5) Do not use this apparatus near water.
- 6) Clean only with dry cloth.
- 7) Do not block any ventilation openings. Install in accordance with the manufacturer's instructions.
- 8) Do not install near any heat sources such as radiators, heat registers, stoves, or other apparatus (including amplifiers) that produce heat.
- 9) Do not defeat the safety purpose of the polarized or grounding-type plug. A polarized plug has two blades with one wider than the other. A grounding type plug has two blades and a third grounding prong. The wide blade or the third prong are provided for your safety. If the provided plug does not fit into your outlet, consult an electrician for replacement of the obsolete outlet.
- 10) Protect the power cord from being walked on or pinched particularly at plugs, convenience receptacles, and the point where they exit from the apparatus.
- 11) Only use attachments / accessories specified by the manufacturer.
- 12) Use only with the cart, stand, tripod, bracket, or table specified by the manufacturer, or sold with the apparatus. When a cart is used, use caution when moving the cart / apparatus combination to avoid injury from tip-over.
- 13) Unplug this apparatus during lightning storms or when unused for long periods of time.
- 14) Refer all servicing to qualified service personnel. Servicing is required when the apparatus has been damaged in any way, such as power-supply cord or plug is damaged, liquid has been spilled or objects have fallen into the apparatus, the apparatus has been exposed to rain or moisture, does not operate normally, or has been dropped.
- 15) To prevent electric shock, ensure the grounding pin on the AC cord power plug is securely connected.



## FCC STATEMENT

This equipment has been tested and found to comply with the limits for a Class B digital device, pursuant to Part 15 of the FCC Rules. These limits are designed to provide reasonable protection against harmful interference in a residential installation. This equipment generates, uses and can radiate radio frequency energy and, if not installed and used in accordance with the instructions, may cause harmful interference to radio communications. However, there is no guarantee that interference will not occur in a particular installation. If this equipment does cause harmful interference to radio or television reception, which can be determined by turning the equipment off and on, the user is encouraged to try to correct the interference by one or more of the following measures:

- Reorient or relocate the receiving antenna.
- Increase the separation between the equipment and receiver.
- Connect the equipment into an outlet on a circuit different from that to which the receiver is connected.
- Consult the dealer or an experienced radio/TV technician for help.

This device complies with Part 15 of the FCC Rules. Operation is subject to the following two conditions: (1) This device may not cause harmful interference, and (2) this device must accept any interference received, including interference that may cause undesired operation.

### FCC Caution:

**To assure continued compliance, use only shielded interface cables when connecting to computer or peripheral devices. Any changes or modifications not expressly approved by Panasonic Corporation of North America could cause harmful interference and would void the user's authority to operate this device.**

### FCC Declaration of Conformity Model No. TH-42PZ700U, TH-50PZ700U, TH-58PZ700U

Responsible Party: Panasonic Corporation of North America  
One Panasonic Way, Secaucus, NJ 07094  
Contact Source: Panasonic Consumer Electronics Company  
1-888-VIEW-PTV (843-9788)  
email: consumerproducts@panasonic.com

### CANADIAN NOTICE:

For Models TH-42PZ700U, TH-50PZ700U, TH-58PZ700U  
This Class B digital apparatus complies with Canadian ICES-003.

## WARNING/CAUTION

### WARNING

**SMALL PARTS CAN PRESENT CHOKING HAZARD IF ACCIDENTALLY SWALLOWED.**  
**KEEP SMALL PARTS AWAY FROM YOUNG CHILDREN.**  
**DISCARD UNNEEDED SMALL PARTS AND OTHER OBJECTS, INCLUDING PACKAGING MATERIALS AND PLASTIC BAGS/SHEETS TO PREVENT THEM FROM BEING PLAYED WITH BY YOUNG CHILDREN, CREATING THE POTENTIAL RISK OF SUFFOCATION.**

#### ■ Set up

**Do not place the Plasma TV on sloped or unstable surfaces.**

- The Plasma TV may fall off or tip over.

**Do not place any objects on top of the Plasma TV.**

- If water spills onto the Plasma TV or foreign objects get inside it, a short-circuit may occur which could result in fire or electric shock. If any foreign objects get inside the Plasma TV, please consult an Authorized Service Center.

**This Plasma TV is for use only with the following optional accessories. Use with any other type of optional accessories may cause instability which could result in the possibility of injury.**

(All of the following accessories are manufactured by Matsushita Electric Industrial Co., Ltd.)

- Wall-hanging bracket (Vertical) TY-WK42PV3U (TH-42PZ700U, TH-50PZ700U, TH-58PZ700U)
- Wall-hanging bracket (Angled) TY-WK42PR3U (TH-42PZ700U, TH-50PZ700U)

**Always be sure to ask a qualified technician to carry out set-up.**

- Two or more people are required to install and remove the television. If two people are not present, the television may be dropped, and personal injury may result.

**Transport only in upright position!**

- Transporting the unit with its display panel facing upright or downward may cause damage to the internal circuitry.

#### ■ AC Power Supply Cord

**The Plasma TV is designed to operate on 120 V AC, 60 Hz. Securely insert the power cord plug as far as it will go.**

- If the plug is not fully inserted, heat may be generated which could cause fire. If the plug is damaged or the wall socket plate is loose, they should not be used.

**The included power cord is for use with this unit only.**

**Do not use any power cord other than that provided with this TV.**

- Doing so may cause fire or electric shocks.

**Do not handle the power cord plug with wet hands.**

- Doing so may cause electric shocks.

**Do not do anything that might damage the power cable. When disconnecting the power cable, hold the plug, not the cable.**

- Do not make any modifications to, place heavy objects on, place near hot objects, heat, bend, twist or forcefully pull the power cable. Doing so may cause damage to the power cable which can cause fire or electric shock. If damage to the cable is suspected, have it repaired at an Authorized Service Center.

#### ■ If problems occur during use

**If a problem occurs (such as no picture or no sound), or if smoke or an abnormal odor is detected from the Plasma TV, unplug the power cord immediately.**

- Continued use of the TV under these conditions might cause fire or permanent damage to the unit. Have the TV evaluated at an Authorized Service Center. Servicing of the TV by any unauthorized personnel is strongly discouraged due to its high voltage dangerous nature.

**If water or foreign objects get inside the Plasma TV, if the Plasma TV is dropped, or if the cabinet becomes damaged, disconnect the power cord plug immediately.**

- A short may occur, which could cause fire. Contact an Authorized Service Center for any repairs that need to be made.

### CAUTION

**Do not cover the ventilation holes.**

- Doing so may cause the Plasma TV to overheat, which can cause fire or damage to the Plasma TV.

**If using the pedestal, leave a space of 3 15/16 " (10 cm) or more at the top, left and right, 1 49/64 " (4.5 cm) or more at the bottom, and 2 3/4 " (7 cm) or more at the rear.**

#### ■ When using the Plasma TV

**Be sure to disconnect all cables before moving the Plasma TV.**

- Moving the TV with its cables attached might damage the cables which, in turn, can cause fire or electric shock.

**Disconnect the power plug from the wall outlet as a safety precaution before carrying out any cleaning.**

- Electric shocks can result if this is not done.

**Clean the power cable regularly to prevent it from becoming dusty.**

- Built-up dust on the power cord plug can increase humidity which might damage the insulation and cause fire. Unplug the cord from the wall outlet and clean it with a dry cloth.

**This Plasma TV radiates infrared rays; therefore, it may affect other infrared communication equipment.**

**Install your infrared sensor in a place away from direct or reflected light from your Plasma TV.**

**Do not climb up onto the television or use it as a step.**

**(Young children should be made particularly aware of this caution.)**

- If the unit falls over or becomes damaged through misuse, injury may result.

**The TV will still consume some power as long as the power cord is inserted into the wall outlet.**

## Notes

#### ■ Do not display a still picture for a long time

This causes the image to remain on the plasma screen ("Image retention"). This is not considered a malfunction and is not covered by the warranty.

#### Typical still images

- Channel number and other logos
- Image displayed in 4:3 mode
- SD Card photo
- Video game
- Computer image



To prevent "Image retention", the screen saver is automatically activated after a few minutes if no signals are sent or no operations are performed. (p. 55)

#### ■ Setup

- Do not place the unit where it's exposed to sunlight or other bright light (including reflections).
- Use of some types of fluorescent lighting may reduce the remote control's transmission range.

# Accessories/Optional Accessory

Check you have all the items shown.

## Accessories

Remote Control Transmitter  
● N2QAYB000100



Batteries for the Remote Control Transmitter (2)  
● AA Battery

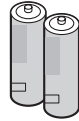

Antenna Adapter  
● F-Type for 5C-2V



Cable clasper (2)

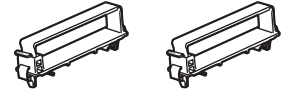

AC cord

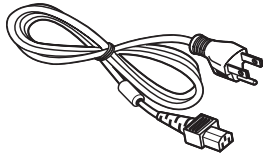

Pedestal  
● TBL2AX00231 (TH-50PZ700U)  
● TBL2AX00241 (TH-58PZ700U)  
● TBL2AX00251 (TH-42PZ700U)

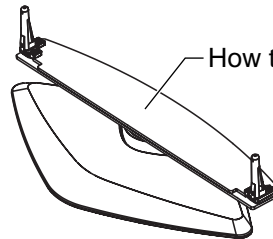

How to assemble (p.7)

Operating Instructions

Product Registration Card (U.S.A.)

Quick Setup Guide  
(For viewing HD programming)

Customer Care Plan Card (U.S.A.)

## Installing the remote's batteries

1

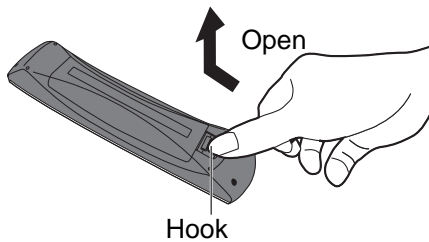

2

Note the correct polarity (+ or -).

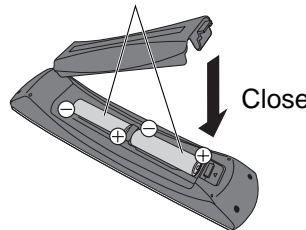

### Caution

- Incorrect installation may cause battery leakage and corrosion, resulting in damage to the remote control.
- Do not mix old and new batteries.
- Do not mix different battery types (such as alkaline and manganese batteries).
- Do not use rechargeable (Ni-Cd) batteries.
- Do not burn or break batteries.
- Make a note of the remote control codes before changing batteries in case the codes are reset. (p. 41)

## Optional Accessory

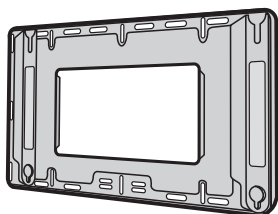

### Wall-hanging bracket

(vertical)

- TY-WK42PV3U (TH-42PZ700U, TH-50PZ700U, TH-58PZ700U)

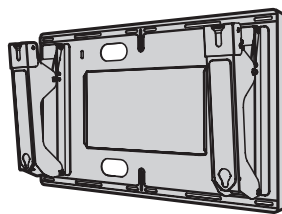

(angle)

- TY-WK42PR3U (TH-42PZ700U, TH-50PZ700U)

### Note

- In order to maintain the TV's performance and safety, be absolutely sure to ask your dealer or a licensed contractor to secure the wall-hanging brackets.
- Carefully read the instructions accompanying the plasma TV stand or pedestal, and be absolutely sure to take steps to prevent the TV from tipping over.
- Handle the TV carefully during installation since subjecting it to impact or other forces may cause its paneling to crack.

## Attaching the pedestal to TV

### Assembling the pedestal

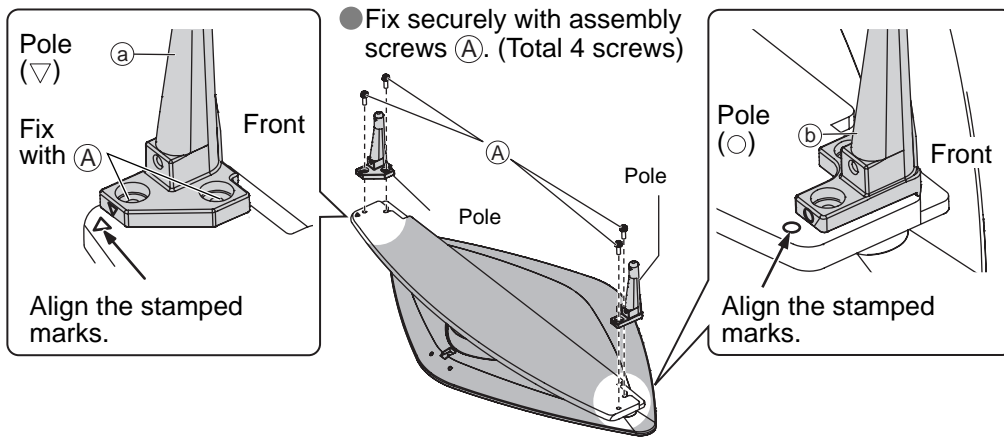

### Accessories

Assembly screw  
(4 of each)

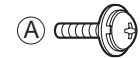

M5 x 16 (For 42", 50")  
M6 x 20 (For 58")

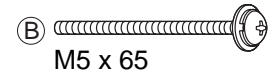

M5 x 65

Pole (2)

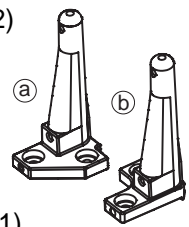

Base (1)

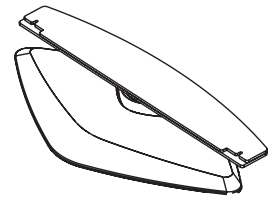

### Set-up

- Carry out work on a horizontal and level surface.

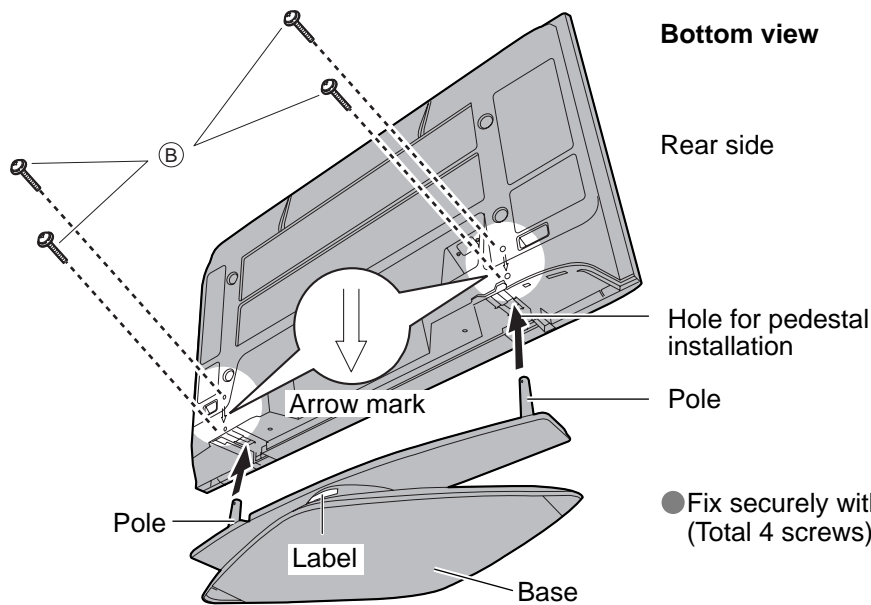

#### Warning

**Do not disassemble or modify the pedestal.**

- Otherwise the TV may fall over and become damaged, and personal injury may result.

#### Caution

**Do not use any television or displays other than those given in these Operating Instructions.**

- Otherwise the TV may fall over and become damaged, and personal injury may result.

**Do not use the pedestal if it becomes warped or physically damaged.**

- If you use the pedestal while it is physically damaged, personal injury may result. Contact your nearest Panasonic Dealer immediately.

**During set-up, make sure that all screws are securely tightened.**

- If sufficient care is not taken to ensure screws are properly tightened during assembly, the pedestal will not be strong enough to support the TV, and it might fall over and become damaged, and personal injury may result.

**Use the accessory fall-prevention brackets to secure the TV.**

- If the TV is knocked or children climb onto the pedestal with the TV installed, the TV may fall over and personal injury may result.

# To Prevent TV from Falling Over

- The TV must be fastened to both a base and a wall.

## Securing to a base

- Fix pedestal and base together with band.

### For 42" and 50"

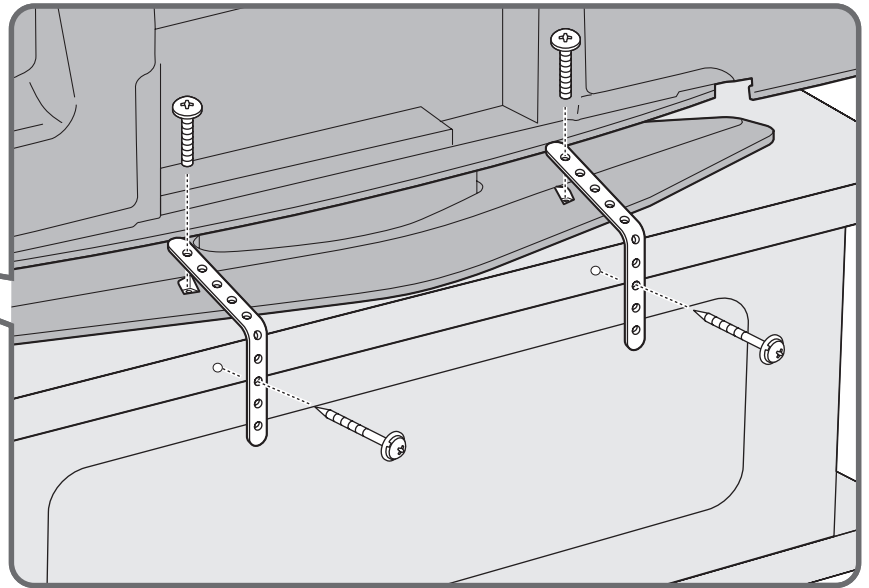
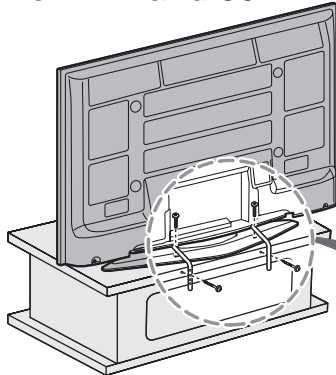

#### Accessories

- ① Band (2)
- ② Screw (2)
  - Nominal diameter  
4 mm x 10 (for 42")  
4 mm x 12 (for 50")
- ③ Wood screw (2)

### For 58"

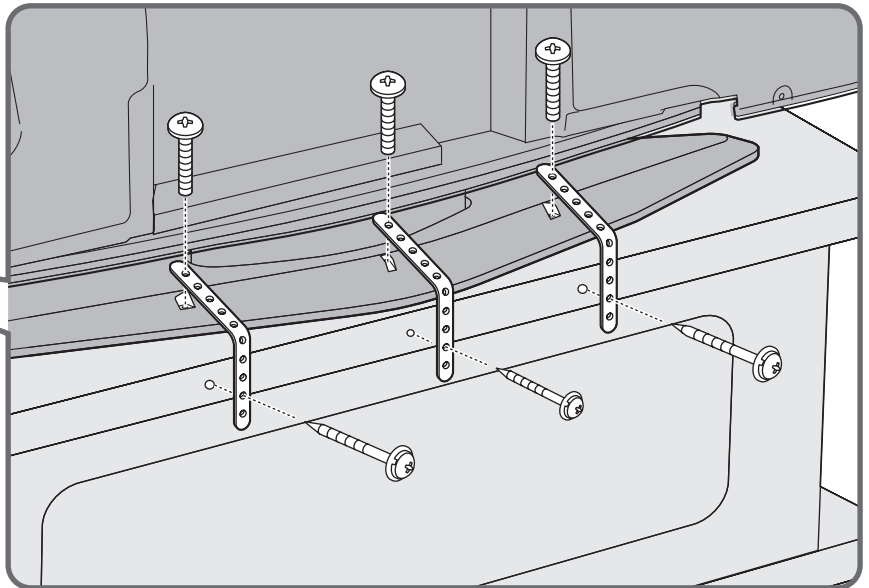
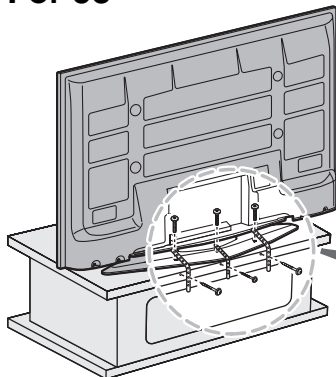

#### Accessories

- ① Band (3)
- ② Screw (3)
  - Nominal diameter  
4 mm x 12
- ③ Wood screw (3)



## Securing to a wall

● Fix to wall or post with strong commercial wire or chain.

### For 42" and 50"

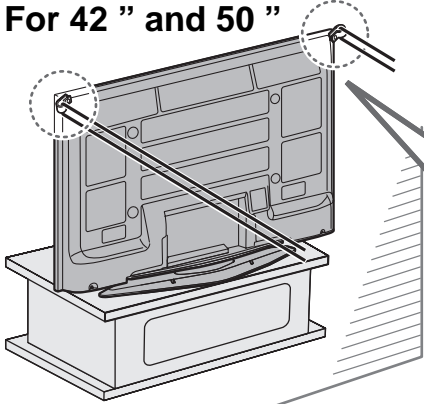

#### Accessories



Clamp (2)

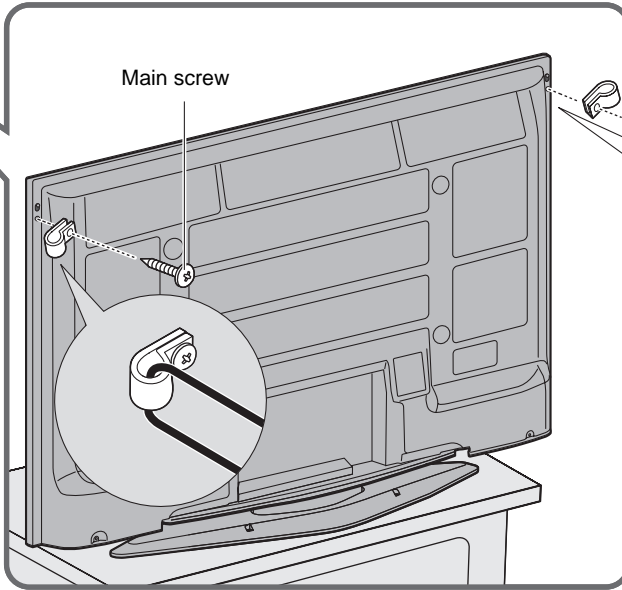

Remove screw

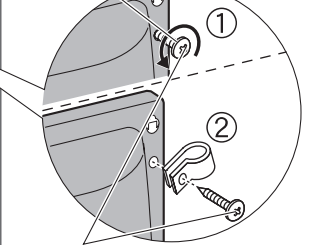

Main screw

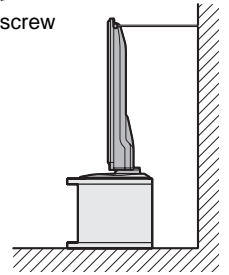

### For 58"

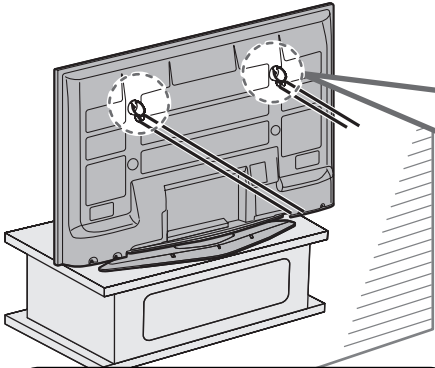

#### Accessories



Hook (2)



Hook securing screw (2)  
• M8 x 35

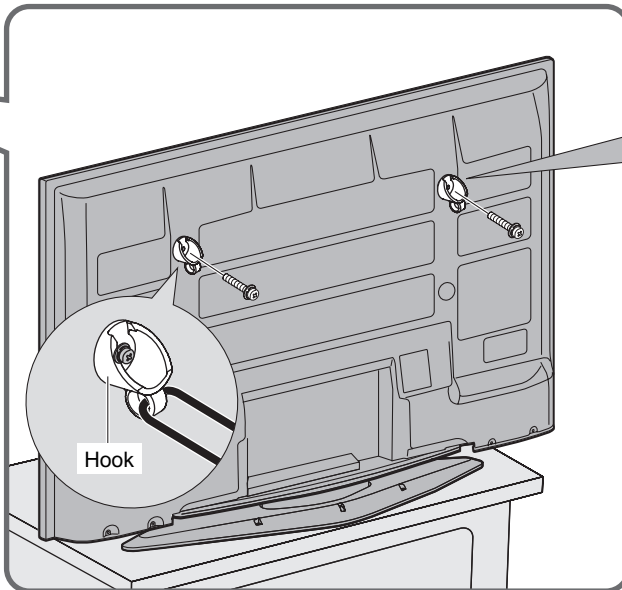

Remove cap

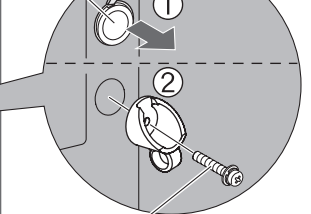

Hook securing screw

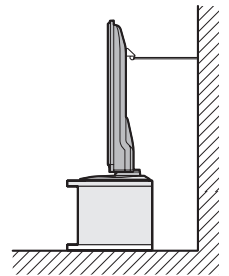

# Before Connection

## Connected Equipment Introduction (Signal source)

### ■ Watching TV

- VHF/UHF Antenna
  - NTSC (National Television System Committee):  
Conventional broadcasting
  - ATSC (Advanced Television Systems Committee):  
Digital TV Standards include digital high-definition television (HDTV), standard-definition television (SDTV), data broadcasting, multi-channel surround-sound audio and interactive television.
- Cable Box/Cable
  - You need to subscribe to a cable TV service to enjoy viewing their programming.
  - You can enjoy high-definition programming by subscribing to a high-definition cable box. The connection can be done with the use of HDMI or Component Video cable.

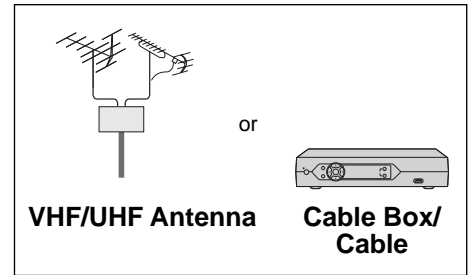

### ■ Recording/playing back with DVD recorder or VCR

- DVD Recorder  
This source has higher resolution through interlace or progressive signal. Connection can be done with the use of Component Video or HDMI cable.
- VCR  
Connection can be done with the use of an RF cable and Composite Video/S Video cable.

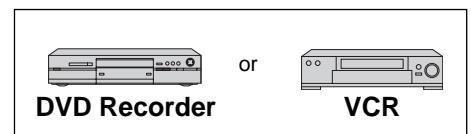

### ■ Watching Satellite

- You can enjoy high-definition programming by subscribing to high-definition satellite source. Connection can be done with the use of HDMI or Component Video cable.

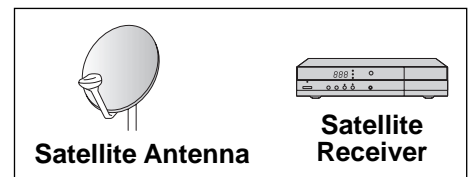

### ■ Enjoying Home theater and DVD recorder with HDMI connection

- Home theater and DVD Recorder  
HDMI connection enables you to enjoy higher quality audio and video with a single cable.

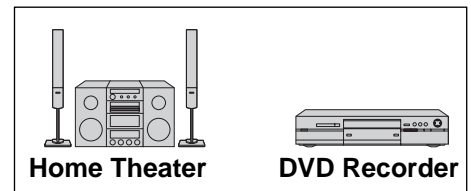

#### Note

- If your Panasonic DVD Recorder is compatible with EZ Sync (HDAVI control 2), you can operate your Panasonic DVD Recorder with this TV's remote control (p. 25 EZ Sync™).
- All cables and external equipment shown in this book are not supplied with the TV.
- For the details of the external equipment's connections, please refer to the operating manuals for the equipment.

## Reference of connection

### ■ Antenna terminal

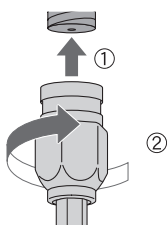

- Firmly tighten by hand.

### ■ Pin terminals

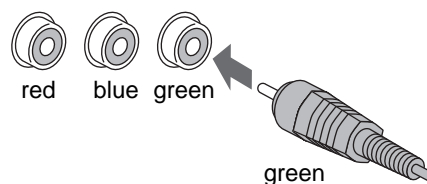

- Match colors of plugs and terminals.
- Insert firmly.

### ■ HDMI terminal

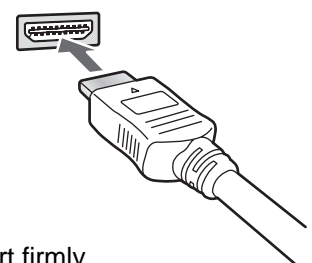

- Insert firmly.

# Basic Connection

## Example 1

## Connecting Antenna (To watch TV)

TV

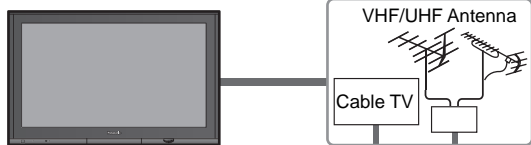

### To connect antenna terminals

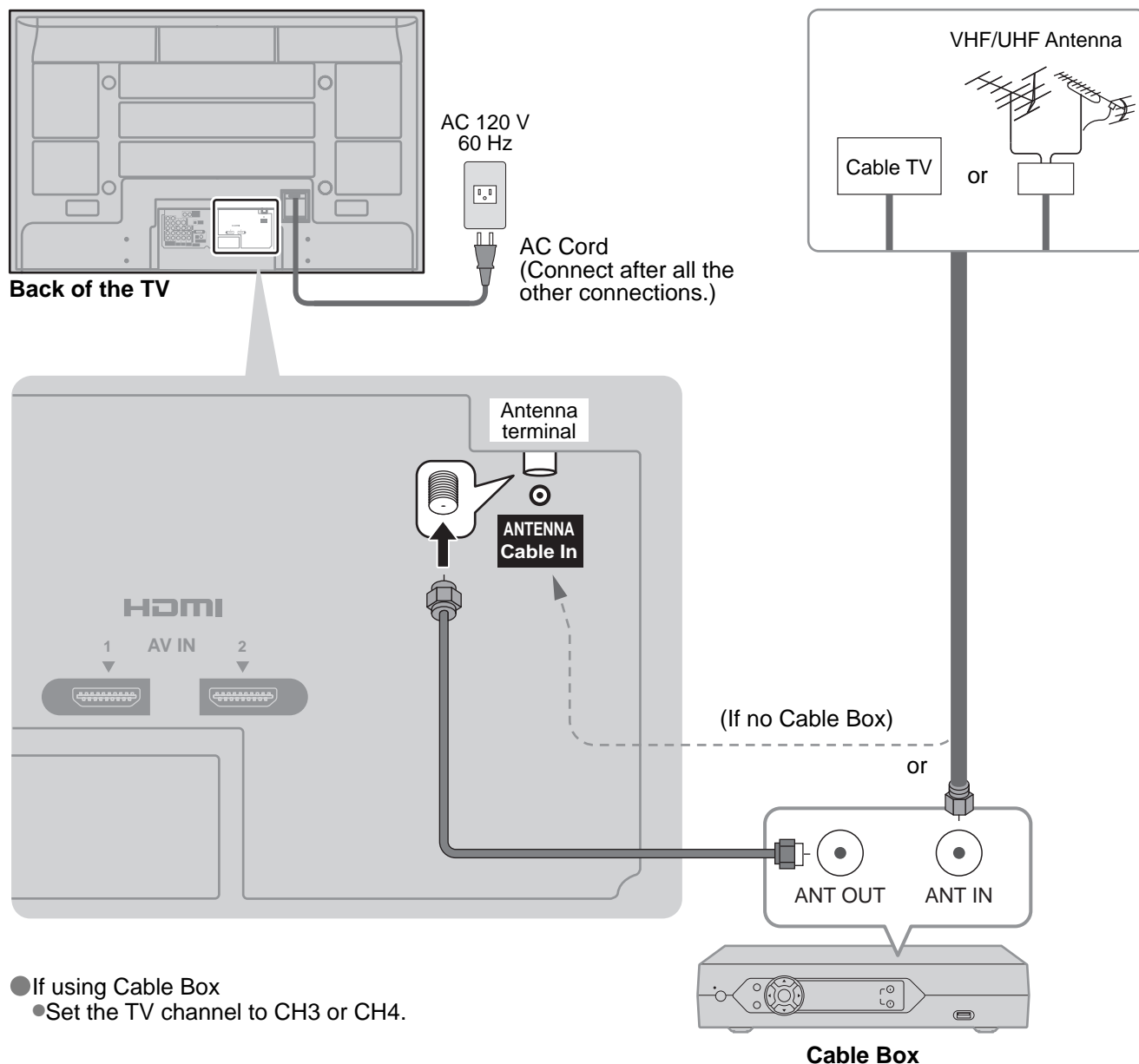

#### Note

- When disconnecting the power cord, be absolutely sure to disconnect the power cord plug from the wall outlet first.
- For additional assistance, visit us at: [www.panasonic.com](http://www.panasonic.com)  
[www.panasonic.ca](http://www.panasonic.ca)

# Basic Connection (Continued)

## Example 2 Connecting DVD recorder (VCR) (To record/playback)

TV

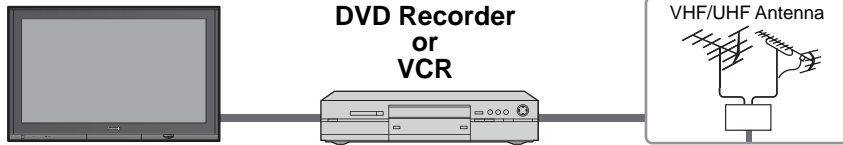

### To connect antenna terminals

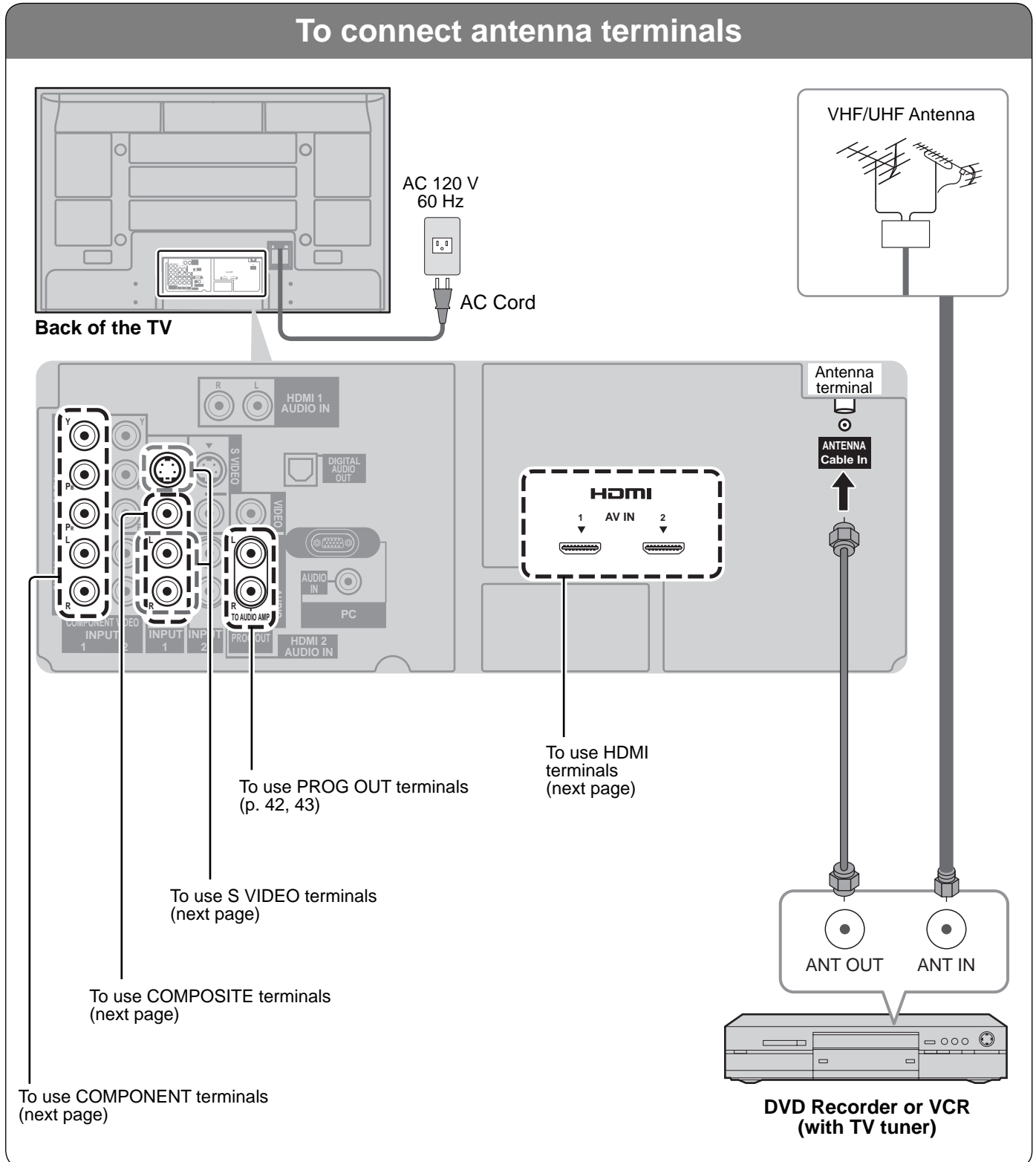

High-Definition

■ To use HDMI terminals

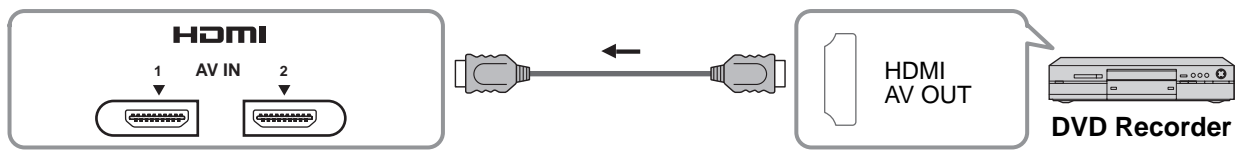

● Connecting to HDMI terminals will enable you to enjoy high-definition digital images and high-quality sound.

■ To use COMPONENT terminals

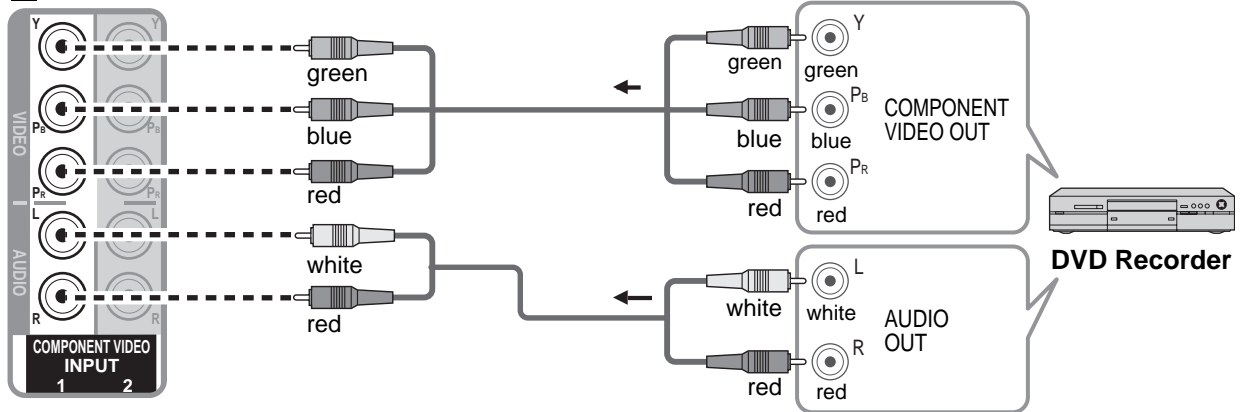

● Recorders may also be connected to COMPOSITE or S VIDEO terminals. (see below)

Standard-Definition

■ To use COMPOSITE terminals

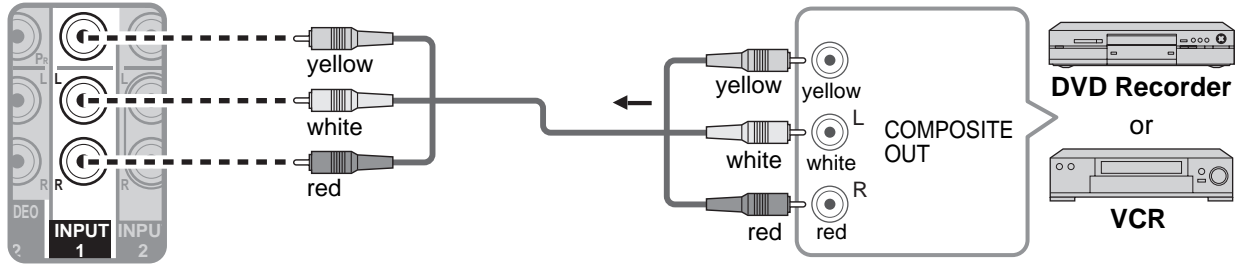

■ To use S VIDEO terminals

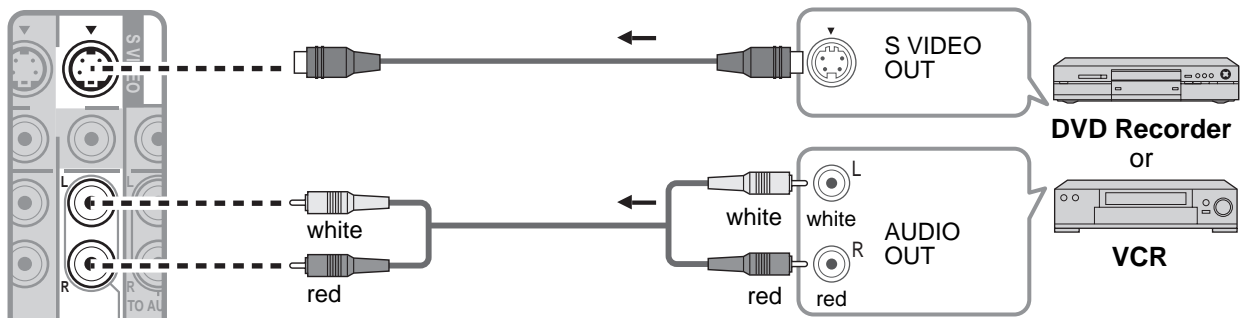

● The S Video input will override the composite video signal when S Video cable is connected. Connect either S Video or Video cable.

● Connecting to S VIDEO terminals will enable you to enjoy greater picture quality than using Composite terminals.

**Note**

- Some programs contain a copyright protection signal to prevent recording.
- When the copyright protection program is displayed, do not connect the other TV monitor through a VCR. Video signals fed through VCRs may be affected by copyright protection systems and the picture will be distorted on the other TV monitor.

# Basic Connection (Continued)

## Example 3 Connecting DVD recorder (VCR) and satellite receiver

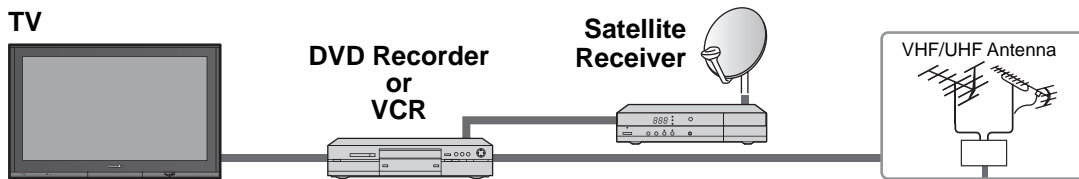

### To connect antenna terminals

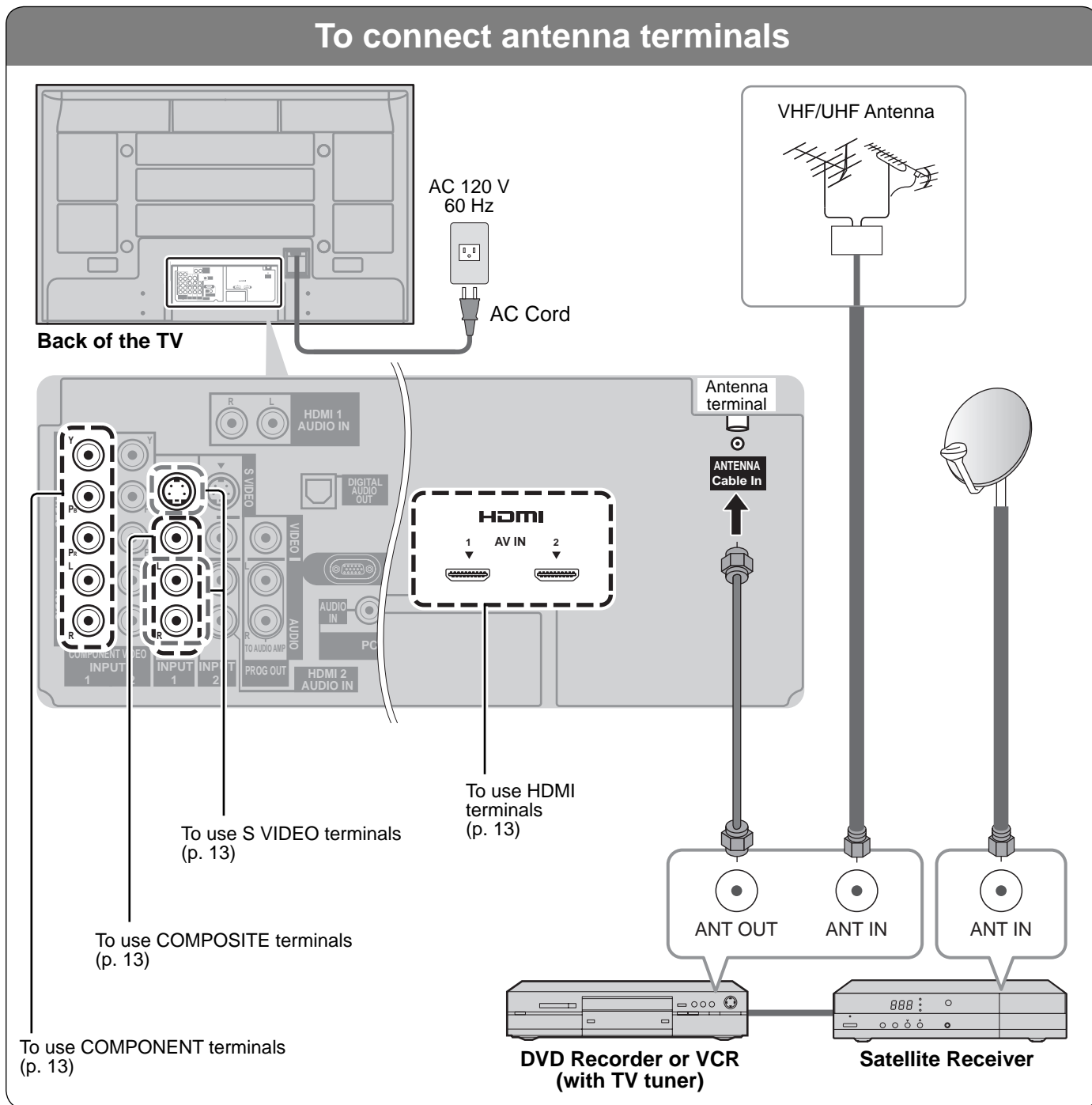

### Connecting TV and DVD recorder (VCR)

Connect in the same way as on p. 13.

**To connect DVD recorder and satellite receiver**

■ **To use HDMI terminals**

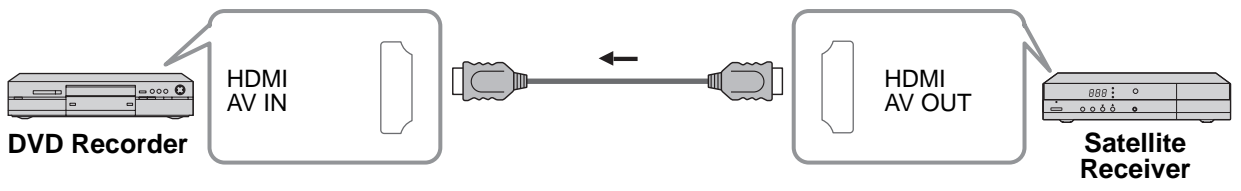

● Connecting to HDMI terminals will enable you to enjoy high-definition digital images and high-quality sound.

■ **To use COMPONENT terminals**

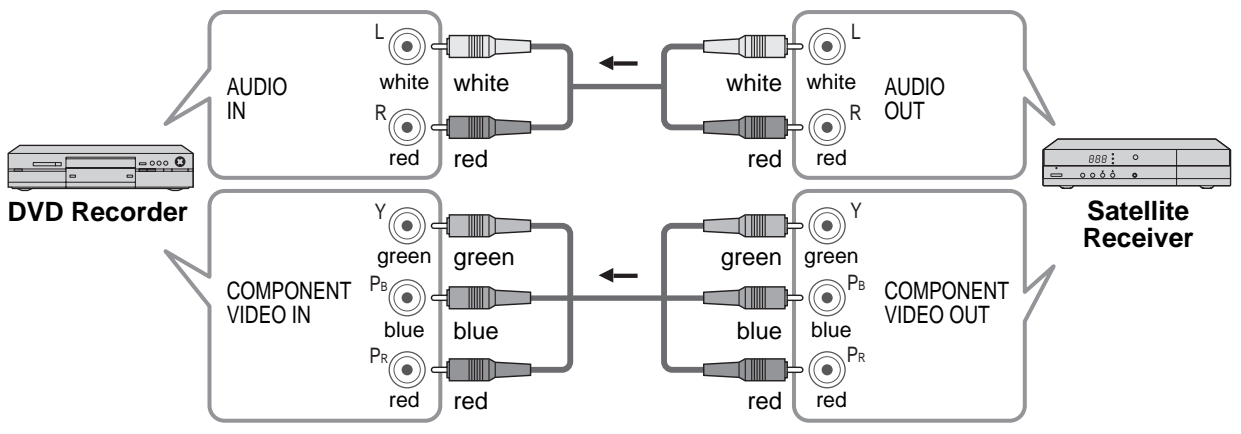

● Satellite Receiver may also be connected to COMPOSITE or S VIDEO terminals. (see below)

**To connect VCR and satellite receiver**

■ **To use COMPOSITE terminals**

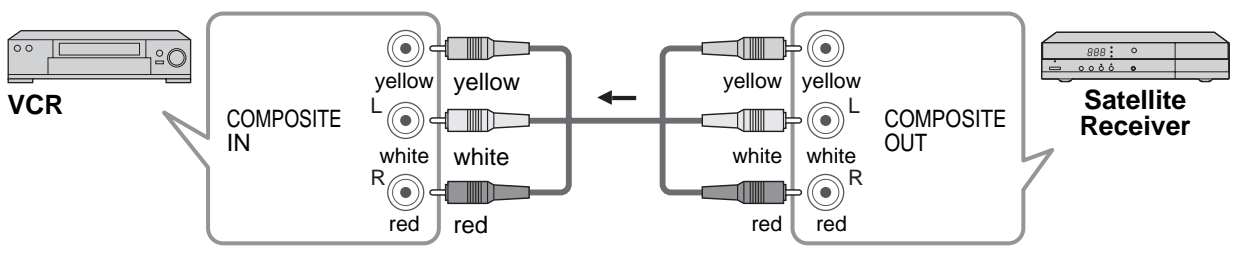

■ **To use S VIDEO terminals**

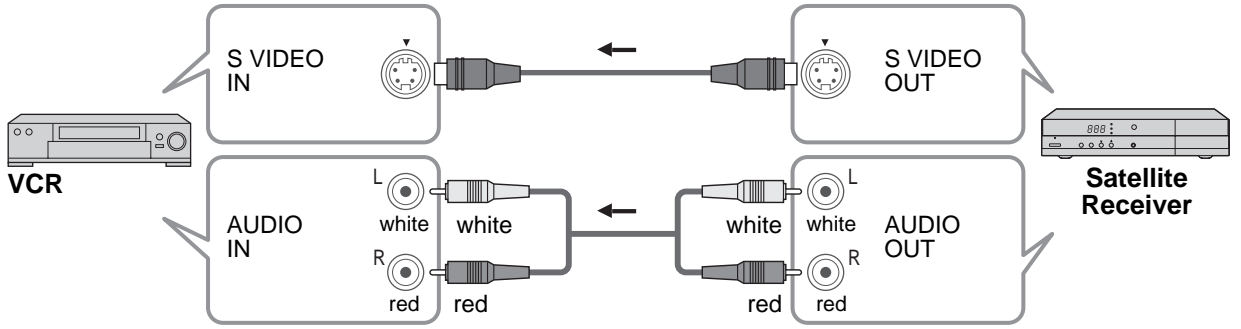

● The S Video input will override the composite video signal when S Video cable is connected. Connect either S Video or Video cable.

● Connecting to S VIDEO terminals will enable you to enjoy greater picture quality than using Composite terminals.

# Basic Connection (Continued)

## Example 4 Connecting Home Theater and DVD recorder

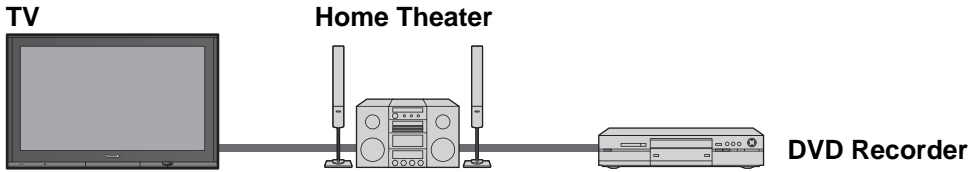

### To connect HDMI terminals

#### Back of the TV

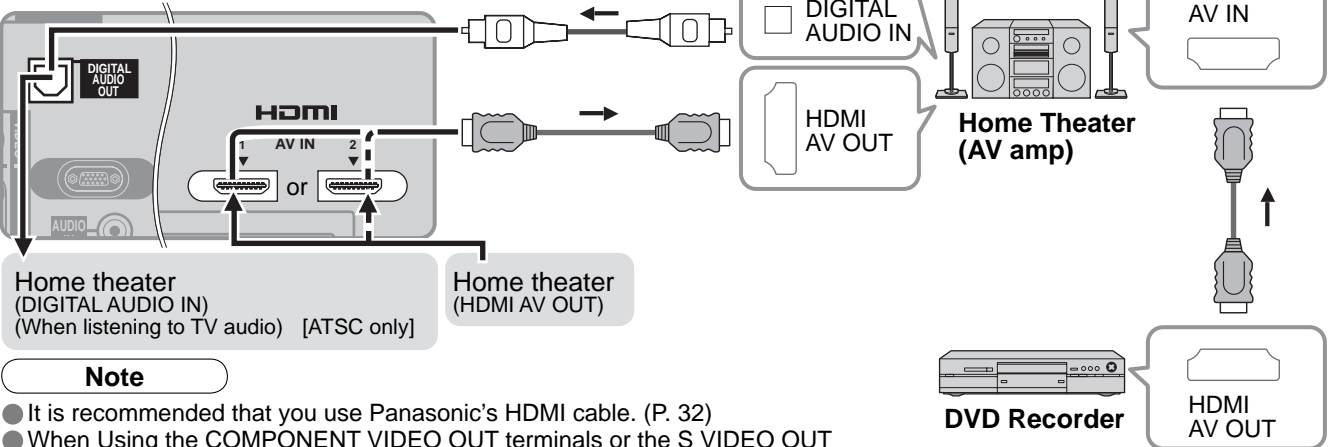

#### Note

- It is recommended that you use Panasonic's HDMI cable. (P. 32)
- When Using the COMPONENT VIDEO OUT terminals or the S VIDEO OUT terminal, refer to p. 15 "To use COMPONENT terminals" or "To use S VIDEO terminals".
- If you connect RAM theater or Player theater with HDMI cable, use audio cable instead of the optical digital audio cable. (p. 43)

### Cable Binding Instructions

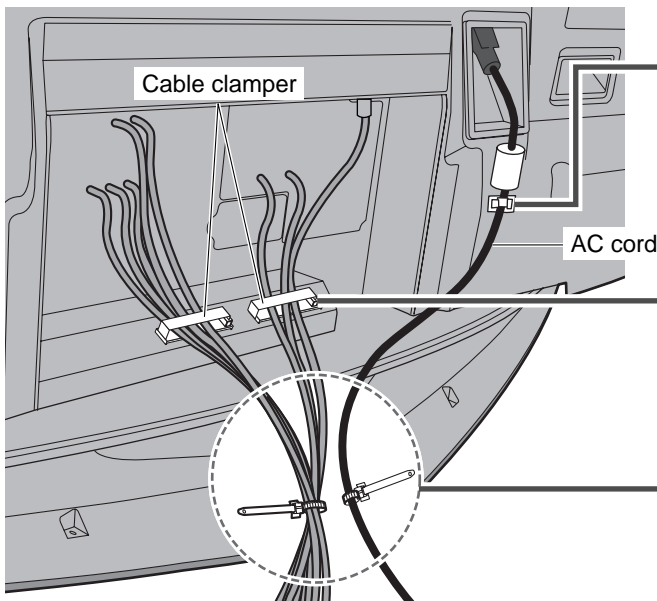

#### To fix

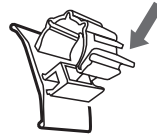

Push until it clicks

#### To release

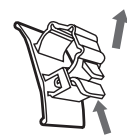

Press catch in and pull away

#### To open

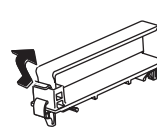

#### To shut

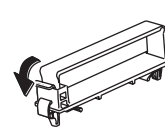

#### To remove from the TV

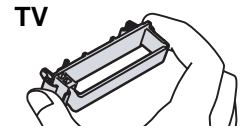

Push both side hooks

#### To attach

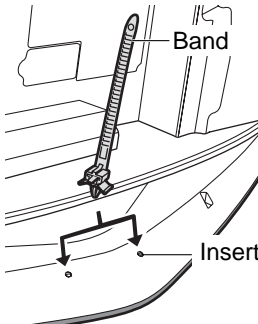

#### To fasten

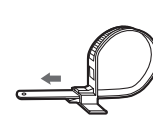

#### To loosen

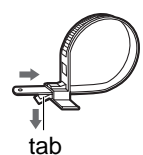

tab

#### Accessories

Band (2)  
(Supplied with Pedestal)

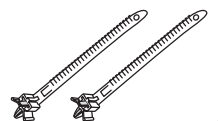

- Do not bundle the RF cable and AC cord together (could cause distorted image).
- Fix cables with Cable clammer and Band as necessary.
- When using the options, follow the option's assembly manual to fix cables.



# Identifying Controls

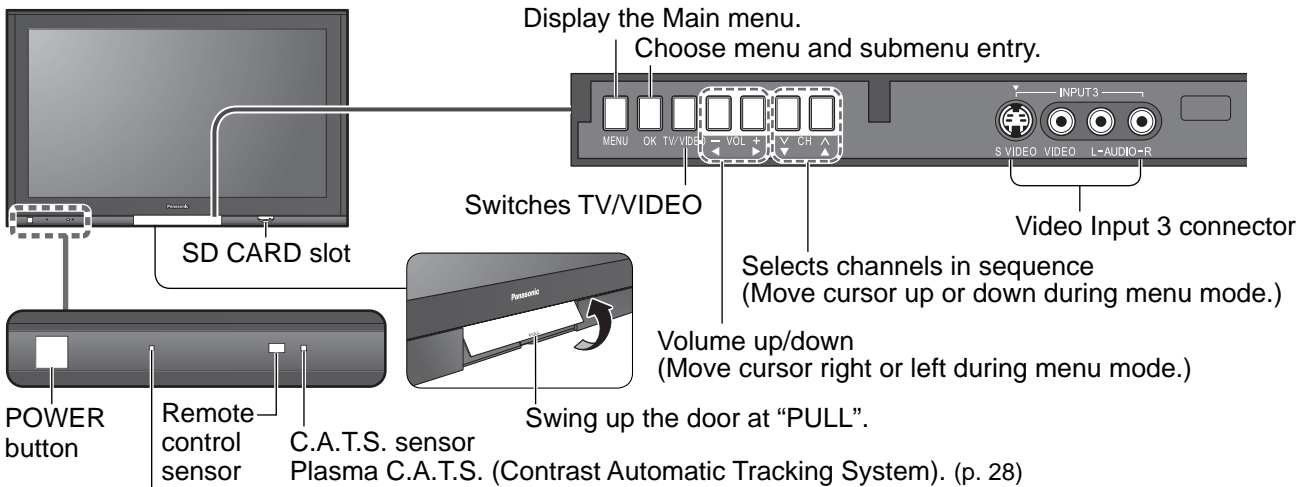

Power indicator (on: red, off: no light)

**Note**

- The TV consumes a limited amount of power as long as the power cord is inserted into the wall outlet.

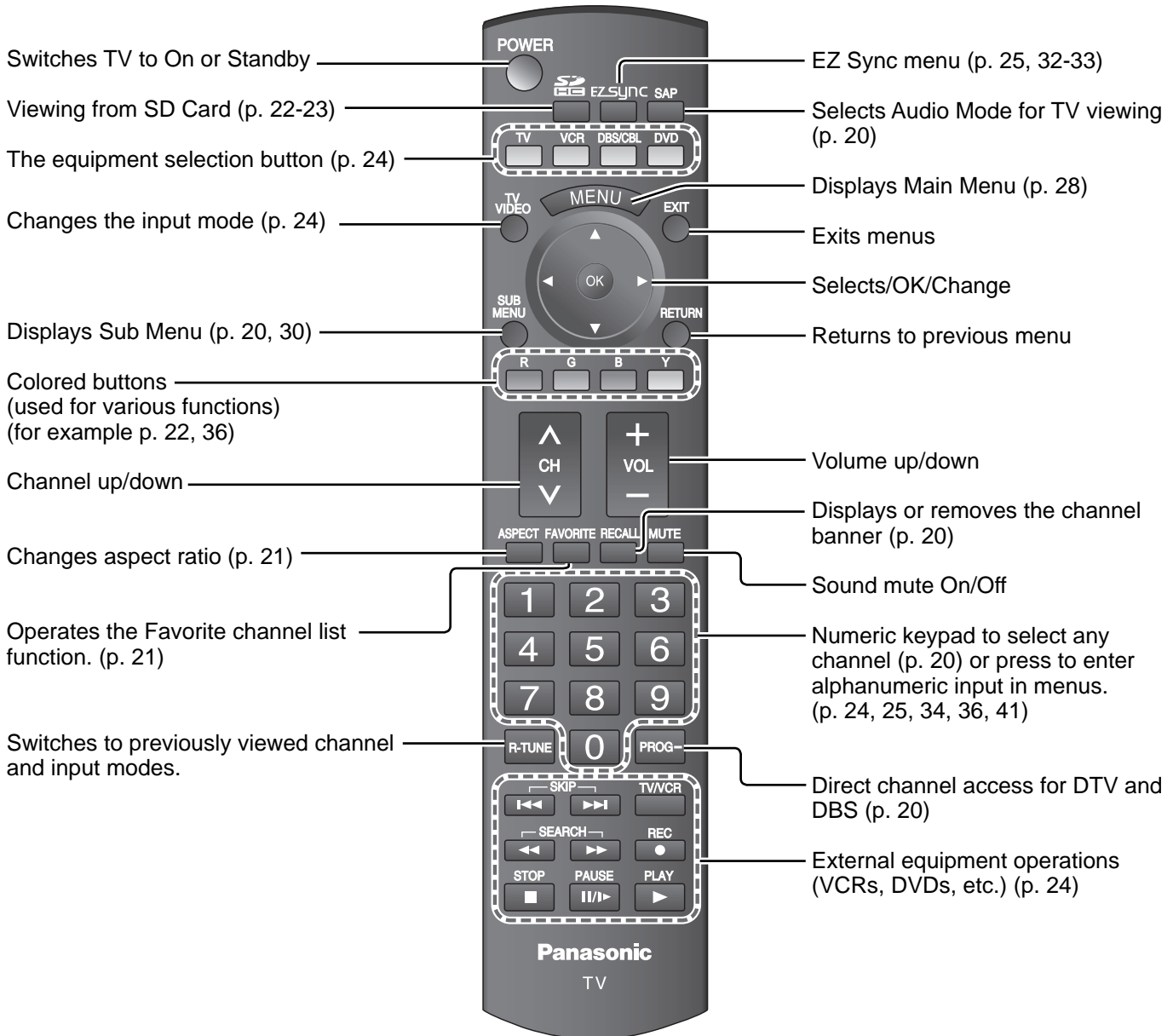

# First Time Setup

“First time setup” is displayed only when the TV is turned on for the first time after the power cord is inserted into a wall outlet and when “Auto power on” (p. 30-31) is set to “No”.

**1 Turn the TV On with the POWER button**

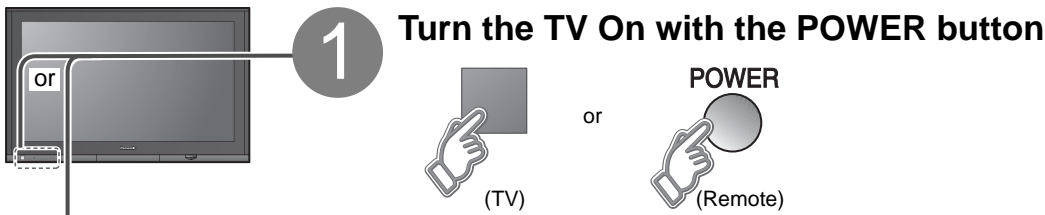

or

(TV) or (Remote)

**2 Select your language**

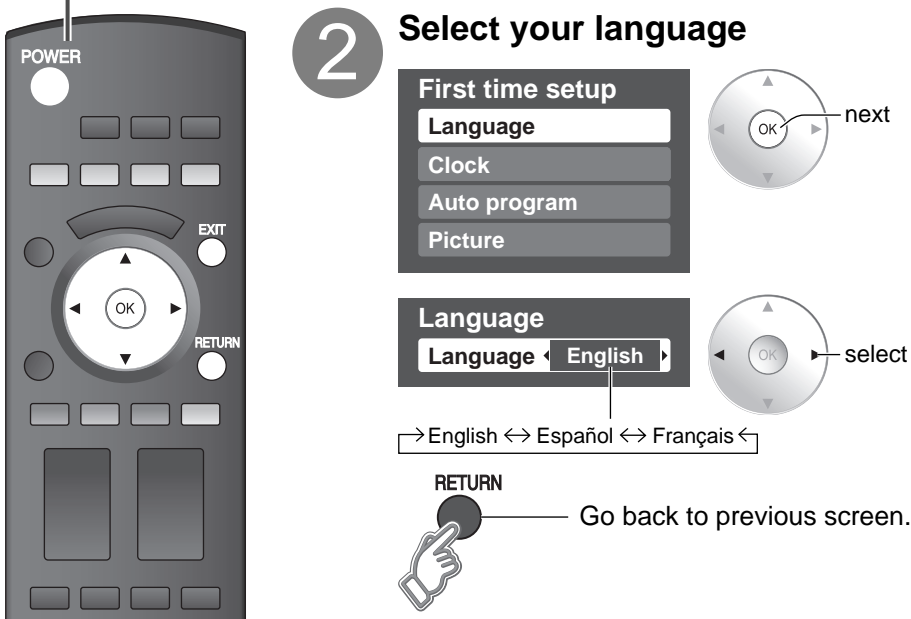

First time setup

Language

Clock

Auto program

Picture

next

Language

Language English

select

English ↔ Español ↔ Français

RETURN

Go back to previous screen.

**3 Adjust the clock**

■ Press to exit from menu screen

EXIT

■ Press to return to previous screen

RETURN

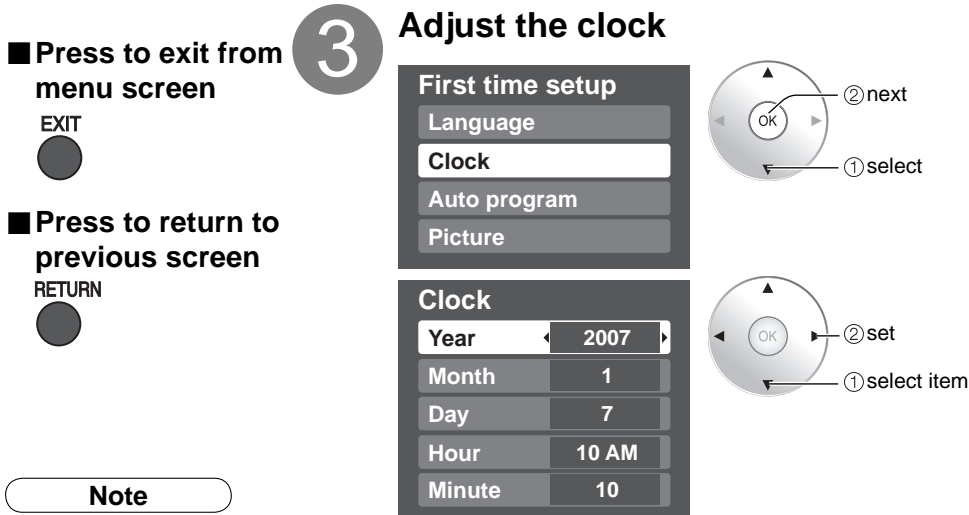

First time setup

Language

Clock

Auto program

Picture

next

select

Clock

Year 2007

Month 1

Day 7

Hour 10 AM

Minute 10

set

select item

## Note

- To change setting (Language/Clock/Auto program/Picture) later, go to Menu screen (p. 28, 30)

Year: Select the year  
 Month: Select the month  
 Day: Select the day  
 Hour: Adjust the hour  
 Minute: Adjust the minute

RETURN

Go back to previous screen.

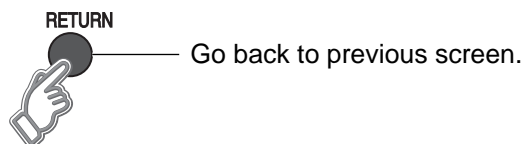

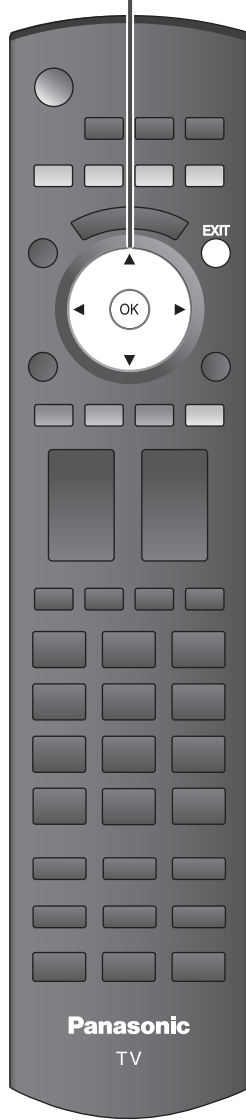

## 4 Auto channel setup

### ① Select "Auto program"

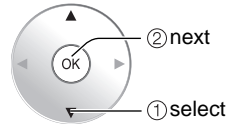
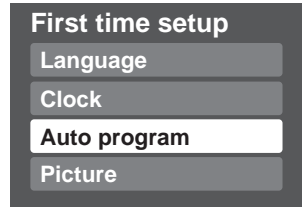

### ② Select "ANT in"

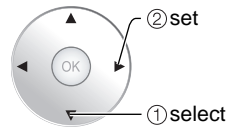
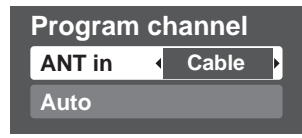

**ANT in**

Cable: Cable TV  
Antenna: Antenna

### ③ Select "Auto"

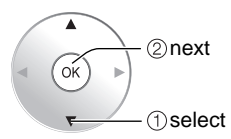
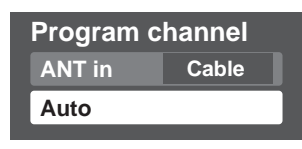

### ④ Select scanning mode (ALL channels/Analog only/Digital only)

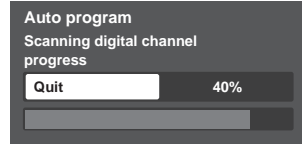
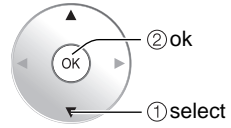
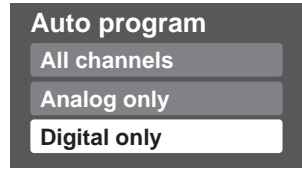

### Start scanning the channels

● Available channels (analog/digital) are automatically set.

All channels: Scans digital and analog channels  
Analog only: Scans Analog channels only  
Digital only: Scans Digital channels only

### ⑤ Confirm registered channels

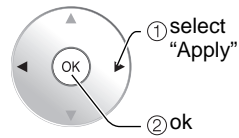
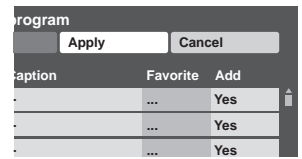

- If OK is not pressed after selecting "Apply", the channels will not be saved.
- If you perform scanning more than twice, previously saved channels are erased.

### ■ Press to exit from menu screen



### Note

● About broadcasting systems

**Analog (NTSC):**  
traditional TV programming

**Digital (ATSC):**  
new programming that allows you to view more channels featuring high-quality video and sound

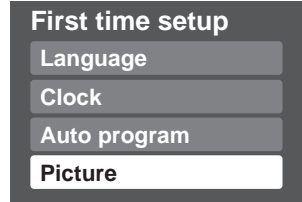

(Refer to p. 28)

# Watching TV

Connect the TV to a cable box/cable, set-top-box, satellite box, or antenna cable (p. 10-15)

**1 Turn power on**



**POWER**



**Note**

- If the mode is not TV, press **TV** and select TV. (p. 24)

**2 Select a channel number**

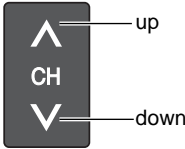

up  
CH  
down

or

1	2	3
4	5	6
7	8	9
0		

■ **To directly input the digital channel number**

**PROG-** When tuning to a digital channel, press the button to enter the minor number in a compound channel number.

example: CH15-1: **1** **5** **PROG-** **1**

## ■ Other Useful Functions (Operate after 2)

### Listen with SAP (Secondary Audio Program)

■ **Selects Audio Mode for watching TV**



● **Digital mode**

Press SAP to select the next audio track (if available) when receiving a digital channel.

Audio track 1 of 2  
(English)

● **Analog mode**

Press SAP to select the desired audio mode.

- Each press of SAP will change the audio mode. (Stereo/SAP/Mono)

### Display the SUB MENU

■ **Press SUB MENU to show sub menu screen.** (p. 30)

This menu consists of shortcuts to convenient functions.

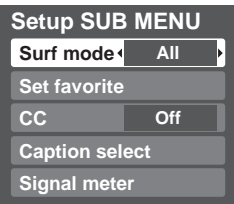

### Information Recall

■ **Displays or removes the channel banner.**



Channel	THE NEWS	Clock
15-2	CC SAP	12:30 pm
ABC-HD	TV-G	⌚ 30
Station identifier	SAP indication	Sleep timer remaining time
Closed caption	Rating Level	Aspect ratio
Signal resolution	Picture mode	

## Change aspect ratio

■ Press ASPECT to cycle through the aspect modes. (p. 50)

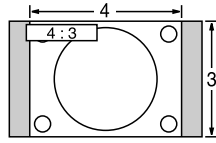

- 480i, 480p: FULL/JUST/4:3/ZOOM
- 1080p, 1080i, 720p: FULL/H-FILL/JUST/4:3/ZOOM

## Call up a favorite channel



### ■ FAVORITE

Channel numbers registered in Favorite are displayed on the favorite tune screen. Select the desired broadcast station with the cursor or use number buttons. (see below)

### Note

- Reselect "Cable" or "Antenna" in "ANT in" of "Program channel" to switch the signal reception between cable TV and antenna. (p. 19, 37)
- The channel number and volume level remain the same even after the TV is turned off.

## Set Favorite Feature

1 Display the SUB MENU.

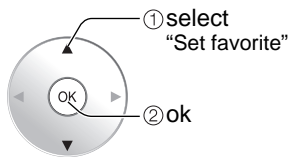
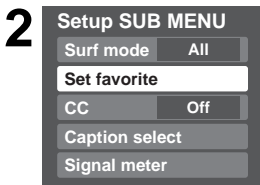
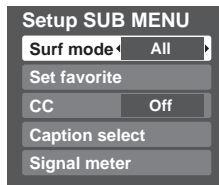

- Press FAVORITE repeatedly to change between pages (1/3, 2/3, 3/3, or exit).

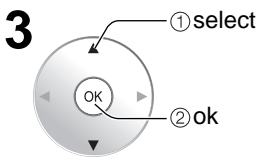

- Press ▲▼ to highlight a position on the list. Then, press OK to save the displayed channel in that position.
- You can also use the NUMBER buttons (1-9 and 0) to select a list number (1-9 and 0). By doing so, the displayed channel will be saved on that list number without pressing OK.

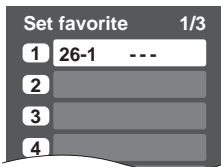

### ● To delete a favorite channel

A saved channel can be removed from the list by holding down OK while its position is highlighted.

### ● To change the page

Pressing ◀ changes the page backward.

Pressing ▶ changes the page forward.

## Use Favorite Feature

1 FAVORITE



Press FAVORITE.

- Press FAVORITE repeatedly to change between pages (1/3, 2/3, 3/3, or exit).

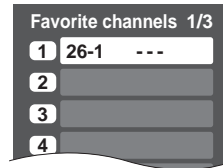

2 select



Press ▲▼ or a Numbered key (1-9 and 0) to highlight a channel on the list.

- Selecting a channel number from the list with the number button will display the channel directly.

3 ok



Press OK to display the highlighted channel.

# Viewing from SD Card

You can view photos taken with a digital camera or digital video camera and saved on an SD card. (Media other than SD Cards may not be reproduced properly.)

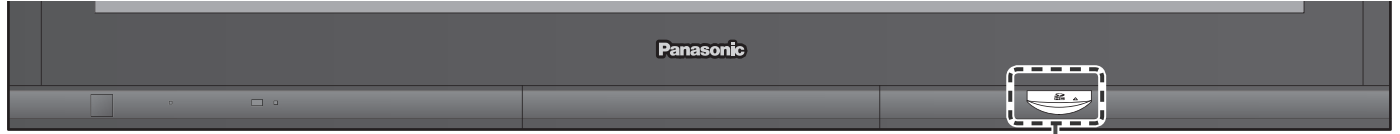

SD Card

● Open the cover

Blue LED

● Insert the card

Label surface  
Push until a click is heard

● Remove the card

Press in lightly on SD Card, then release.

- Compliant card type (maximum capacity):  
SDHC Card (4 GB), SD Card (2 GB), miniSD Card (1 GB) (requiring miniSD Card adapter)
- Blue LED lights while SD Card is inserted if set "SD card LED" to "On" in Setup Menu (p. 30).



- 1
**Insert the SD Card**  
 ● For cautions and details on SD Cards (p. 51)
- 2
**Select the SD mode**  
 or  
**Display menu**  
 → **Select "Memory card"**
- 3
**Select the data to be viewed**

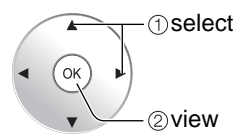
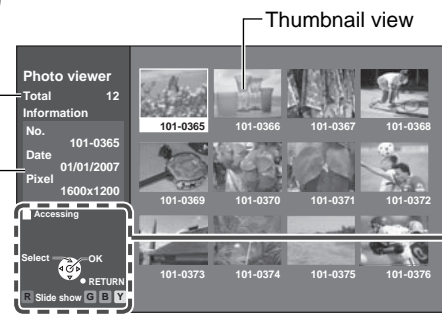

- Press to return to TV
- Press to exit from menu screen  
EXIT
- Press to return to the previous screen  
RETURN

Selected picture information is displayed.  
**No.:** Image number or file name is displayed.  
**Date:** Date of recording is displayed.  
**Pixel:** Display resolution is displayed.

Total number of images

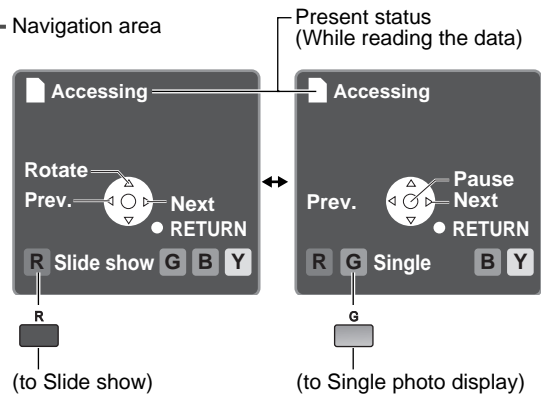

**Note**

● Depending on the JPEG format, "Information" contents may not be displayed correctly. Refer to p. 51 (Data format for SD card browsing) for details.

# 4 View



Displays one at a time  
Navigation area

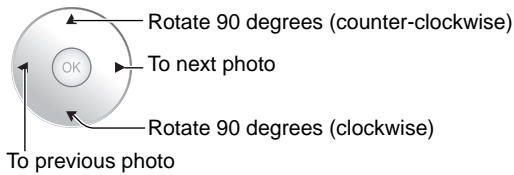

● To display/hide Navigation area →

## To change the view (Slide show mode, adjusting images, etc.)

### ■ To watch photos in Slide show mode

In ③ or ④

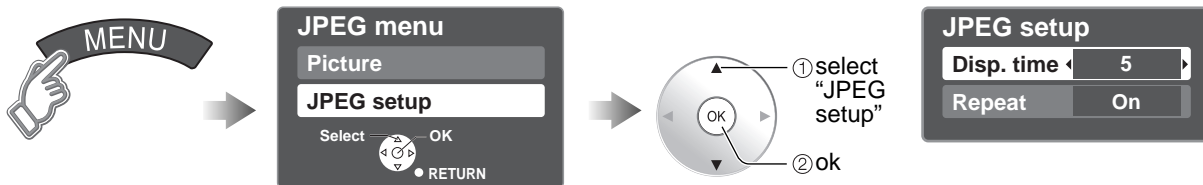

<b>Disp. time</b>	You can set how many seconds each image is displayed in Slide show mode. (1-10/15/20/30/45/60/120 sec)
<b>Repeat</b>	Turn the slide show Repeat function On or Off.

#### Note

- For large image sizes, the display time will be longer than the number of seconds set.
- To stop in mid-cycle → Press

### ■ To adjust picture

When MENU is pressed, the "JPEG menu" is displayed.

In ③ or ④

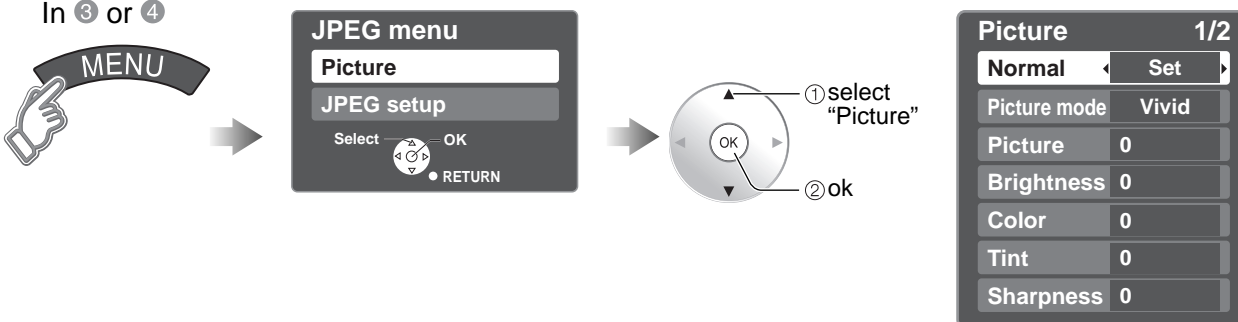

Picture menu (p. 28)

## Viewing from a GalleryPlayer SD Card

You can view high-definition art and photography purchased on or downloaded to an SD card. GalleryPlayer provides pre-loaded SD cards with copy-protected imagery and images for download to your computer that can be saved on an SD card for display on your television.

# Watching Videos and DVDs

If you have some equipment connected to the TV, you can easily watch videos and DVDs using the TV's remote control.

## Input Select

You can select the external equipment to access.

To operate other manufacturers' equipment, you need to register the code of the equipment. (p. 41)

- 1** With the connected equipment turned On **Display the Input select menu**
- 2** **Select the input mode**  
 Press corresponding NUMBER button on the remote control to select the input of your choice.  
 or  
 Select the input of your choice, then press OK.  
 ● During the selection, if no action is taken for several seconds, the "Input select" menu disappears.  
 ● The terminal and label of the connected equipment is indicated. To label each of the inputs please refer to p. 38-39.
- 3** **Select the remote control mode**  
 Press the key to select
- 4** **Operate the connected equipment, pointing remote control at the equipment.** (example)

■ **To return to TV**  
 TV VIDEO → 1

**Note**  
 ● For details, see the manual of the equipment.

	VCR MODE	DVD MODE
REC	VCR Record	Record
SKIP	—	Skip Reverse/Forward
SEARCH	Rewind/Fast Forward	Reverse/Forward
STOP	Stop	Stop
PAUSE	Pause	Pause
PLAY	Play	Play

(For other operations, see p. 44)



## EZ Sync™

If you connect equipment that has “HDAVI Control 2” function to a TV with HDMI cable, you can enjoy using more convenient functions. For details, refer to “EZ Sync Control” on p. 32-33.

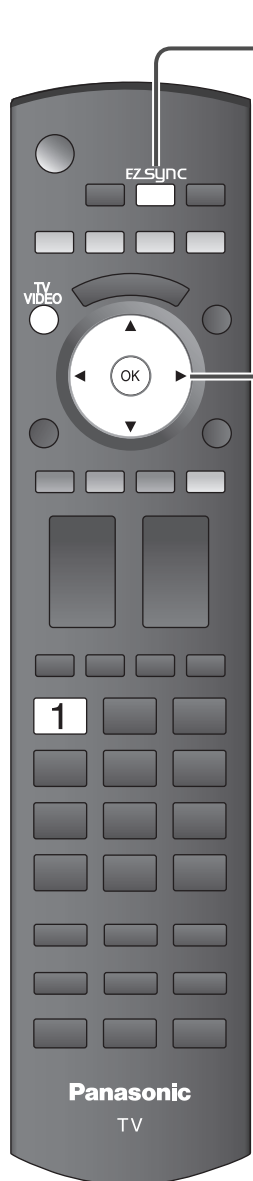

**1 Display EZ Sync menu**



**2 Select the equipment**

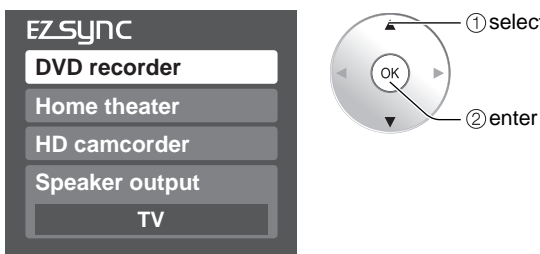

**3 Operate**

You can operate the selected equipment with the TV's remote control. Follow the menu of the equipment and enjoy watching. For the remote control operations, refer to p. 32.

### Note

- For details, see the manual for the equipment or ask your local dealer.

■ To return to TV



# Displaying PC Screen on TV

The screen of the PC connected to the unit can be displayed on the TV.

You can also listen to PC sound with the audio cable connected. To connect PC (p. 42)

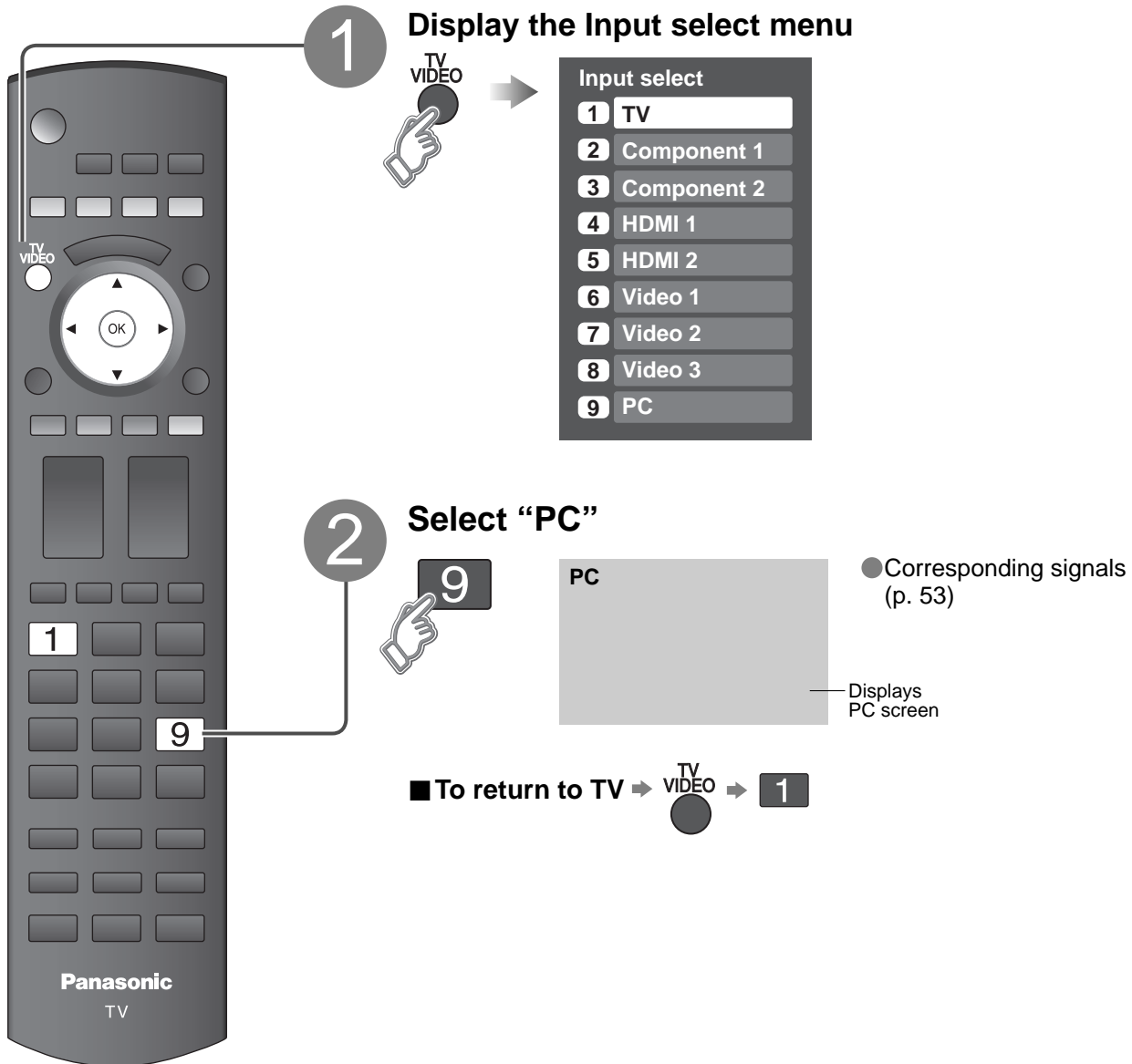

■ **PC menu setting** (changed as desired)

● Making settings → "How to Use Menu Functions" ① to ④ (p. 28)

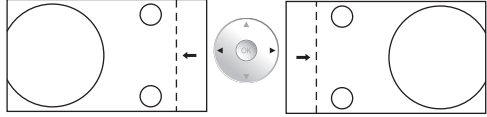
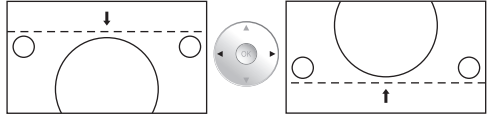
Menu	Item	Adjustments/Configurations (options)	
Picture	PC adjust	Normal	Resets PC adjust ( <b>Set/No</b> )
		Sync	<ul style="list-style-type: none"> <li>● H &amp; V: The H and V sync signals are input from the HD/VD connector. (p. 53)</li> <li>● On G: Uses a synchronized signal on the Video G signal, which is input from the G connector. (p. 53)</li> </ul>
		Dot clock	Alleviates the problem if a picture appears to be vertically-striped, flickers partially or is blurred.
		H-position	Adjust the horizontal position. 
		V-position	Adjust the vertical position. 
		Clock phase	Alleviates the problem if the whole picture appears to flicker or is blurred. First adjust the Dot Clock to get the best possible picture, then adjust the Clock Phase so that a clear picture appears. <b>Note</b> It may not be possible to display a clear picture due to poor input signals.
		Input resolution	Switches to wide display. <ul style="list-style-type: none"> <li>● Input signal switched from VGA to WVGA</li> <li>● Input signal switched from XGA to WXGA</li> </ul>
		H-frequency V-frequency	Displays the H (Horizontal)/V (Vertical) frequencies. <ul style="list-style-type: none"> <li>● Display range</li> <li>Horizontal: 15 - 110 kHz</li> <li>Vertical: 48 - 120 Hz</li> </ul>

● Audio menu (p. 28)

● For PC input, only audio signals can be output from PROG OUT terminals.

# How to Use Menu Functions

Various menus allow you to make settings for the picture, sound, and other functions so that you can enjoy watching TV in your own way.

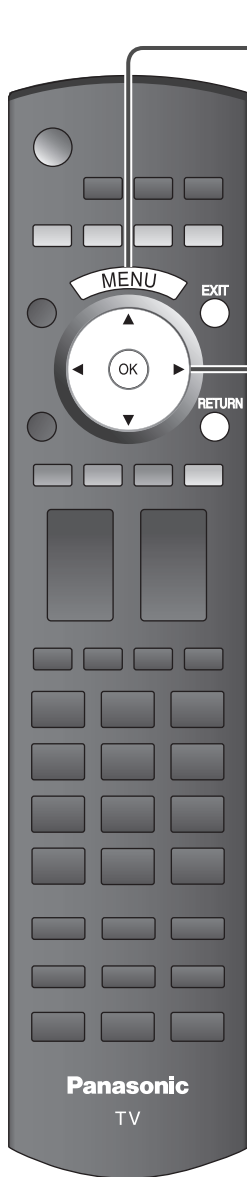

## 1 Display menu



- Displays the functions that can be set (varies according to the input signal)

## 2 Select the menu

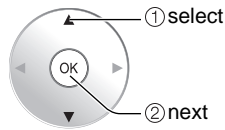
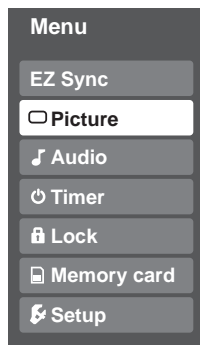

## 3 Select the item

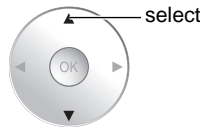
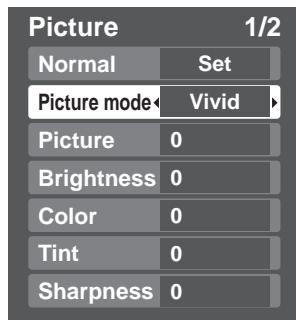

(example: Picture menu)

## 4 Adjust or select

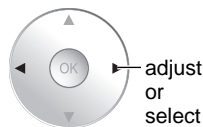
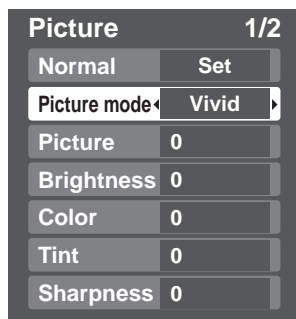

(example: Picture menu)

### Press to exit from menu screen



### Press to return to the previous screen



### Menu list

Menu	Item			
EZ Sync	DVD recorder, Home theater, HD camcorder, Speaker output			
	Picture	Normal		
		Picture mode		
		Picture, Brightness, Color, Tint, Sharpness		
		Color temp.		
		Color mgmt.		
		C.A.T.S.		
		Zoom adjust		
		PC adjust		
		Other adjust	Video NR	
			3D Y/C filter	
	Color matrix			
	Block NR			
Mosquito NR				
Audio	Other adjust	Black level		
		3:2 pulldown		
		HD Size		
		Normal		
		Bass		
	Treble			
	Balance			
	Other adjust	AI sound		
		BBE VIVA 3D		
		BBE		
Surround				
Speaker output				
	HDMI 1 in			
	HDMI 2 in			
	Audio leveler			
Timer	Sleep, Timer 1-5			
Lock				
Memory Card	Memory card			

## Adjustments/Configurations (alternatives)

### [DVD recorder/Home theater/HD camcorder]

Select equipment to access and operate. (p. 32)

### [Speaker output]

Select audio output. **(Home theater/TV)** (p. 32)

● EZ Sync menu is accessible directly by pressing the EZ Sync button on the remote control. ➔  (p. 25)

Resets all picture adjustments to factory default settings except for "Other adjust" <b>(Set/No)</b>	Normal	Set
Basic picture mode <b>(Vivid/Standard/Cinema/Custom)</b> (p. 52)	Picture mode	Vivid
Adjusts color, brightness, etc. for each picture mode to suit your taste	Picture	+20
	Brightness	0
	Color	0
	Tint	0
	Sharpness	0
Selects level of warm colors (red) and cool colors (blue) <b>(Cool/Normal/Warm)</b>	Color temp.	Cool
On: Enhances green and blue color reproduction, especially outdoor scenes. <b>(On/Off)</b>	Color mgmt.	On
Adjusts the brightness and gradation accordingly, to optimize contrast. <b>(Off/On)</b>	C.A.T.S.	Off
Adjusts vertical alignment and size when aspect setting is "ZOOM" (p. 50)	Zoom adjust	
Sets PC display (p. 27)	PC adjust	
Reduces noise, commonly called snow. Leave it off when receiving a strong signal. <b>(Off/On)</b>	Video NR	Off
Minimizes noise and cross-color in the picture. <b>(On/Off)</b>	3D Y/C filter	Off
Selects image resolution of component-connected devices <b>(HD/SD)</b>	Color matrix	SD
● SD: Standard Definition HD: High Definition		
● Only 480p signal accepted; regular TV (NTSC) is not available.		
Reduces noise of specific digital signals of DVD, STB, etc. <b>(On/Off)</b>	Block NR	Off
Reduces HDTV flicker noise in the contoured sections of an image <b>(Off/On)</b>	Mosquito NR	Off
Selects Dark or Light. Valid only for external input signals. <b>(Dark/Light)</b>	Black level	Light
Transfers film to video. <b>(On/Off)</b>	3:2 pulldown	Off
Selects between 95 % (Size 1) or 100 % (Size 2) for the scanning area when HDTV. <b>(Size 1/ Size 2)</b>	HD Size	size1
Select "Size 1" if noise is generated on the edges of the screen.		
● Size 1: Selected item for "HD size". Scanning 95%		
● Size 2: Selected item for "HD size". Scanning 100%		
Resets Bass, Treble and Balance adjustments to factory default settings. <b>(Set/No)</b>	Normal	Set
Increases or decreases the bass response.	Bass	+ 4
Increases or decreases the treble response.	Treble	0
Emphasizes the left / right speaker volume.	Balance	0
Equalizes overall volume levels across all channels and external inputs. <b>(On/Off)</b>	AI sound	On
BBE VIVA HD3D (High-Definition 3D) Sound provides musically accurate natural 3D image with Hi-Fi sound. The clarity of the sound is improved by BBE while the width, depth and height of sound image are expanded by BBE's proprietary 3D sound process. BBE ViVa HD3D Sound is compatible with all TV programs including news, music, dramas, movies, sports and electronic games. <b>(On/Off)</b>	BBE VIVA 3D	On
BBE High Definition Sound restores clarity and presence for better speech intelligibility and musical realism. <b>(On/Off)</b>	BBE	On
Enhances audio response when listening to stereo. <b>(On/Off)</b>	Surround	Off
Switches to "Off" when using external speakers <b>(On/Off)</b>	Speaker output	On
● "AI sound", "Surround", and "Audio leveler" do not work if "Off" is selected		
Selects according to the signal when HDMI is connected <b>(Auto/Digital/Analog)</b>	HDMI1 in	Auto
● Auto: Automatically selects Analog / Digital signal	HDMI2 in	Auto
Minimizes volume disparity after switching to external inputs	Audio leveler	0
The TV can automatically turn On/Off at the designated date and time (p. 40)	Sleep	60
Locks the channels and programs (p. 34)		
Displays SD card data (p. 22)	Memory card	

● In AV mode, the Audio menu and Setup menu give fewer options.

# How to Use Menu Functions

Various menus allow you to make settings for the picture, sound, and other functions so that you can enjoy watching TV in the way best suited for you.



## 1 Display menu



- Displays the functions that can be set (varies according to the input signal)

## 2 Select "Setup"

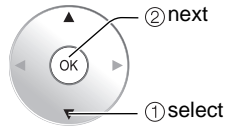
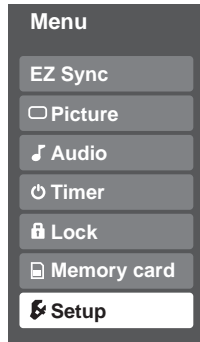

## 3 Select the item

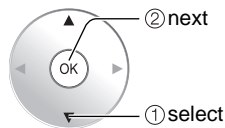
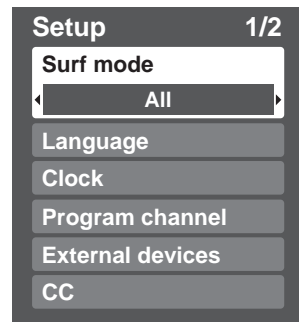

### Press to exit from menu screen



### Press to return to the previous screen



## 1 Display Sub Menu



## 2 Select the item

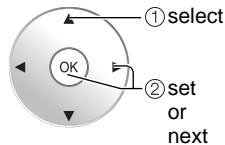
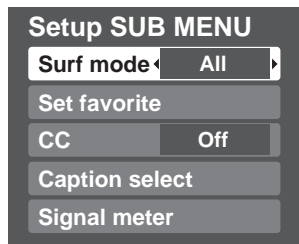

### Menu list

Menu	Item		
Setup	Surf mode		
	Language		
	Clock		
	Program channel		
	External devices	Input labels	
		Monitor out	
	CC		
	EZ Sync setting	EZ Sync	
		Power off link	
		Power on link	
Default speakers			
Other adjust	Auto power on		
	Side bar		
	No signal shut-off		
	No action shut-off		
	SD card LED		
About			
Reset			

### Sub menu list

Menu	Item	
Setup SUB MENU	Surf mode	
	Set favorite	
	CC	
	Caption select	
	Signal meter	

# (Continued)

Adjustments/Configurations (alternatives)	
Sets the mode to select the channel with Channel up/down button <b>(Favorite/All)</b> ● Favorite: Only channels registered as FAVORITE (p. 37)	Surf mode <input type="radio"/> All <input checked="" type="radio"/>
Selects the screen menu language (p. 18)	Language <input type="text"/>
Adjusts the clock (p. 18)	Clock <input type="text"/>
Sets channels (p. 36)	Program channel <input type="text"/>
Selects the terminal and label of the external equipment (p. 38)	
<b>[Comp. 1/Comp. 2/HDMI 1/HDMI 2/Video 1/Video 2/Video 3]</b> To prevent howling and image oscillation, stops output of the pictures and audio specified in this menu. (p. 38) <b>(On/Off)</b>	
Displays subtitles (Closed Caption) (p. 38)	CC <input type="text"/>
Controls equipment connected to HDMI terminals (p. 32) <b>(On/Off)</b> ● "Power off link", "Power on link", and "Default speakers" cannot be selected if "Off" is set.	EZ Sync <input type="radio"/> On <input checked="" type="radio"/>
Sets "Power off link" of HDMI connection equipment (p. 32) <b>(Set/No)</b>	Power off link <input type="radio"/> Set <input checked="" type="radio"/>
Sets "Power on link" of HDMI connection equipment (p. 32) <b>(Set/No)</b>	Power on link <input type="radio"/> Set <input checked="" type="radio"/>
Selects the default speakers (p. 32) <b>(TV/Theater)</b>	Default speakers <input type="radio"/> TV <input checked="" type="radio"/>
Turns TV On automatically when the cable box or a connected device is turned On <b>(No/Set)</b> ● The "Sleep" timer, "On / Off timer", and "First time setup" will not function if "Auto power on" is set. (p. 40)	Auto power on <input type="radio"/> No <input checked="" type="radio"/>
Change the brightness of the side bar <b>(Bright/Off/Dark/Mid)</b> (4:3 mode only) The recommended setting is "Bright" to prevent panel "Image retention". (p. 52)	Side bar <input type="radio"/> Bright <input checked="" type="radio"/>
To conserve energy, the TV automatically turns off when NO SIGNAL continues more than 10 minutes. <b>(Set/No)</b> <b>Note</b> ● Not in use when setting "Auto power on", "On/Off Timer", "Lock", "SD mode", PC input display or Digital channel. ● "No signal shut-off was activated" will be displayed for about 10 seconds when the TV is turned on for the first time after turning the power off by "No signal shut-off". ● The on-screen display will flash 3, 2 and 1 to indicate the last three (3) remaining minutes prior to the shut-off.	No signal shut-off <input type="radio"/> Set <input checked="" type="radio"/>
To conserve energy, the TV automatically turns off when no operation of remote or front panel key continues more than 3 hours. <b>(No/Set)</b> <b>Note</b> ● Not in use when setting "Auto power on", "On/Off Timer" or PC input display. ● "No action shut-off was activated" will be displayed for about 10 seconds when the TV is turned on for the first time after turning the power off by "No action shut off". ● The on-screen display will flash 3, 2 and 1 to indicate the last three (3) remaining minutes prior to the shut-off.	No action shut-off <input type="radio"/> No <input checked="" type="radio"/>
Set to "On", if you light SD card LED while SD card is inserted. <b>(On/Off)</b>	SD card LED <input type="radio"/> On <input checked="" type="radio"/>
Displays TV version and software license.	About <input type="text"/>
Performing Reset will clear all items set with Setup, such as channel settings. (p. 36)	Reset <input type="text"/>

Adjustments/Configurations (alternatives)	
Sets the mode to select the channel with Channel up/down button <b>(Favorite/All)</b>	
Sets favorite channels. (p. 21)	
Displays Closed Caption. (p. 38) <b>(Off/On)</b>	
Changes the station identifier. (p. 37)	
Checks the signal strength if interference or freezing occurs on a digital image. (p. 36)	

# EZ Sync™ “HDAVI Control™”\*

\* Simultaneously control all Panasonic “HDAVI Control” equipped components using one button on one remote.

Enjoy additional HDMI Inter-Operability with Panasonic products which have “HDAVI Control” function. This TV supports “HDAVI Control 2” function.

Connections to some Panasonic equipment (DVD Recorder DIGA, HD Camcorder, RAM theater, Player theater, Amplifier, etc.) with HDMI cables allow you to interface automatically.

The equipment with “HDAVI Control” function enables the following operations:

Automatic Input Switching, Power on link, Power off link and Speaker control (p. 33).

In addition, the equipment with “HDAVI Control 2” function enables the following operation:

EZ Sync Control only with TV’s remote control (for “HDAVI Control 2”) (p. 33).

EZ Sync “HDAVI Control”, based on the control functions provided by HDMI which is an industry standard known as HDMI CEC (Consumer Electronics Control), is a unique function that we have developed and added. As such, its operation with other manufacturers’ equipment that supports HDMI CEC cannot be guaranteed.

■ For the first time / When adding new equipment, reconnecting the equipment or changing the setup.

After the connection turn the equipment on and then switch the TV on.

Select the input mode to HDMI 1 or HDMI 2 (p. 24), and make sure that an image is displayed correctly.

● This function needs an HDMI compliant (fully wired) cable. Non-HDMI-compliant cables cannot be utilized.

It is recommended that you use Panasonic’s HDMI cable.

Recommended part number:

RP-CDHG15 (4.9 ft/1.5 m), RP-CDHG30 (9.8 ft/3.0 m), RP-CDHG50 (16.4 ft/5.0 m)

**1 Display menu**

**2 Select “Setup”**

**3 Select “EZ Sync setting”**

**4 Select “EZ Sync”**

**5 Select “On”**  
(default is On)

● If no HDMI equipment is connected or standard HDMI equipment (non- “EZ Sync”) is used, set to “Off”.

■ Press to exit from menu screen



■ Press to return to the previous screen



Automatic Input Switching

Speaker control

EZ Sync Control only with TV’s remote control (for “HDAVI Control 2”)

Power on link

Power off link

Default speakers

One-touch theater playback



At the start of the DIGA, Player theater, or RAM theater playback, the TV's input automatically switches to the input based on the playback equipment.

● For the RAM theater, the speakers automatically switch to the theater system.

If using the DIGA operation, the TV's input automatically switches to the DIGA and DIGA menu is displayed.

You can select Home theater, or TV speakers for audio output.

Control theater speakers with the TV's remote control.

This function is available only when Panasonic Amplifier or Player theater is connected.

① Press 

② Select "Speaker output"

③ Select "Home theater" or "TV"

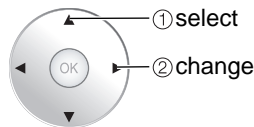

■ **Home theater:** Adjustment for equipment

Volume up / down →



Mute →



● The sound of the TV is muted.

● When the equipment is turned off, TV speakers become active.

● Selecting "Home theater" turns the equipment on automatically if it is in standby mode.

■ **TV:** The TV speakers are active.

In the EZ Sync menu, you can select HDMI connected Panasonic equipment and access it quickly. Continue using your TV's remote control to operate the equipment, pointing it at the TV.



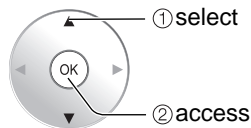

① Press 

② Select the equipment you want to access.



You can select available items only.

■ **Available TV's remote control buttons**

	Move the cursor/Select
	Set/Access
	Return to the previous menu
	Display the Functions menu on the equipment
	Available when the purpose of the keys is displayed on screen

③ Operate the equipment with the TV's remote control, pointing it at the TV.

● To operate the equipment, read the manual of the equipment.

When "Set" is selected (p. 31), TV is turned on automatically and switches to the appropriate HDMI input whenever EZ Sync compatible equipment is initially turned on and Play mode is selected.

When "Set" is selected (p. 31) and the TV is turned off, all connected EZ Sync compatible equipment is also automatically turned off.

● DIGA (Panasonic DVD Recorder) will not turn off if it is still in rec mode.

**Caution:** The TV remains on even if the EZ Sync compatible equipment is turned off.

"TV" is the default setting. To set the Home Theater system as default speakers, change the default speakers setting from "TV" to "Theater". Sound will be output from the Home Theater whenever the TV is powered on.

If the "ONE TOUCH PLAY" key is pressed on the remote control for Panasonic Home Theater system, the following sequence of operations is performed automatically.

① Home Theater power switches On, and playback begins.

② TV power switches On, and the playback screen is displayed.

③ Audio is muted on the TV and switches to the theater system.

# Lock

You can lock specified channels or shows to prevent children from watching objectionable content.

**1 Display menu**

**2 Select "Lock"**

**3 Input your 4-digit password**

**4 Select the Lock mode**

**5 Select the item**

**6 Set**

**Press to exit from menu screen**

**EXIT**

**Caution**

● Make a note of your password in case you forget it. (If you have forgotten your password, consult your local dealer.)

**Note**

● When you select a locked channel, a message will be displayed that allows you to view the channel if you input your password.

**Menu**

- EZ Sync
- Picture
- Audio
- Timer
- Lock**
- Memory card
- Setup

**Create password**

Enter password.

0 - 9

**Lock**

Mode	Off
Channel	Off
Game	Off
Program	Off
Change password	

**Lock**

Mode	Custom
Channel	Off
Game	Off
Program	Off
Change password	

**next**

**select**

**set**

**set**

**select**

**set**

**select**

**set**

You will be asked to enter your password each time you display the Lock menu.

A 4-digit code must be entered to view a blocked program or change rating settings.

- If it is your first time entering the password, enter the password twice in order to register it.
- Off: Unlocks all the lock settings of "Channel", "Game" and "Program".
- All: Locks all the inputs regardless of the lock settings of "Channel", "Game" and "Program".
- Custom: Locks specified inputs of "Channel", "Game" and "Program".
- "Channel", "Game" and "Program" will grey out unless "Custom" is selected in "Mode".

■ To select the channel or the rating of the program to be locked

**Channel lock**

Select up to 7 (1-7) channels to be blocked. These channels will be blocked regardless of the program rating.

- ① Select "Mode" and set to "Custom"
- ② Select channel to lock.

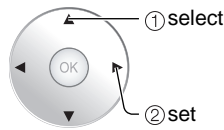
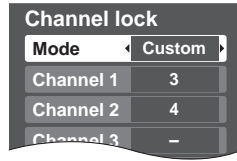

- To lock/unlock all channels: Select "Mode" and set to "All" or "Off".  
All: Locks all channels  
Off: Unlocks all channels

**Game lock**

Locks Channel 3, Channel 4 and external inputs. Select "Game" in ⑤ and set to "On".

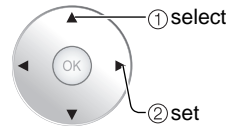

- On: Locks
- Off: Unlocks

**Program lock**

■ To set a rating level  
"V-chip" technology enables restricted shows to be locked according to TV ratings.

- ① Select "Mode" and set to "On".

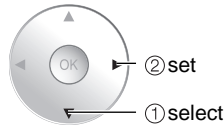
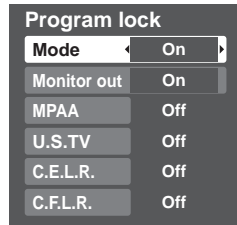

- ③ Select the rating to be locked

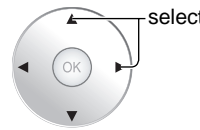

Example of "MPAA" (U.S movie ratings)

NR	No rating
G	General Audience: All ages admitted
PG	Parental Guidance Suggested
PG-13	Parents Strongly Cautioned: Inappropriate for children under 13
R	Restricted: Under 17 requires accompanying parent or adult guardian
NC-17	No one 17 and under admitted
X	Adults only

- To get more information (p. 48)

- ② Select the rating category you wish to follow

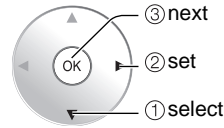
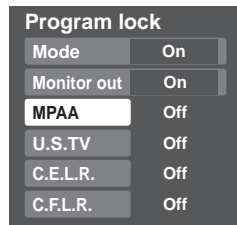

- MPAA: U.S movie ratings
- U.S.TV: U.S TV program ratings
- C.E.L.R.: Canadian English ratings
- C.F.L.R.: Canadian French ratings

■ To disable recording of the locked program

- ➔ Select "Monitor out" and set to "On".

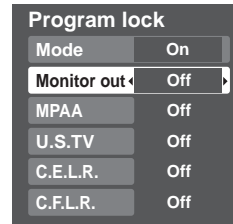

- On: Turns on the monitor terminal output for programs that have been set to "Blocked."
- Off: Turns off the monitor terminal output for programs that have been set to "Blocked."

**Change password**

■ To change the password

- ① In ④, select "Change password" and press OK
- ② Input the new 4-digit password twice

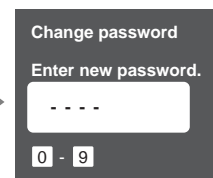
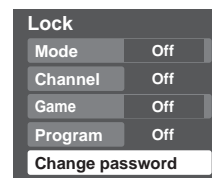

**Note**

- This television is designed to support the "Downloadable U.S. Region Rating System" when available. (Available only in U.S.A.)
- The Off rating is independent of other ratings.
- When placing a block on a specific-age-based-rating level, the Off rating and any other more restrictive ratings will also be blocked.

# Editing and Setting Channels

The current channel settings can be changed according to your needs and reception conditions.

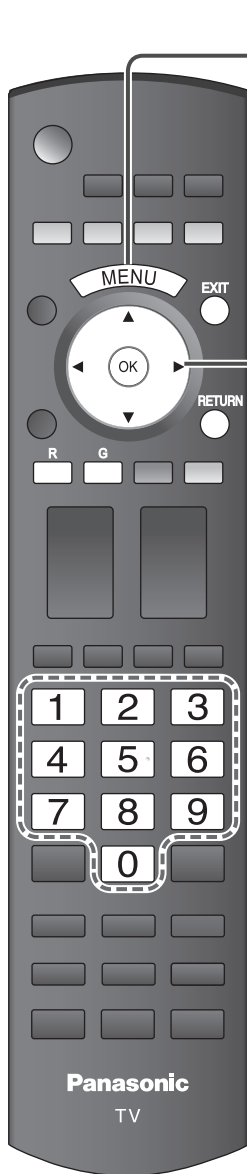

## 1 Display menu



## 2 Select "Setup"

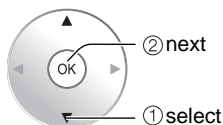
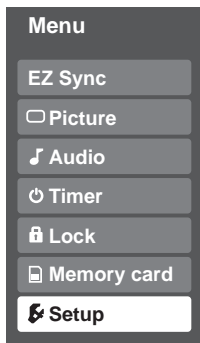

## 3 Select "Program channel"

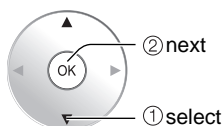
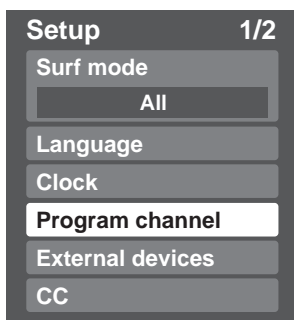

## 4 Select the function

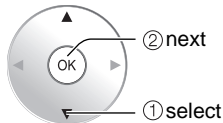
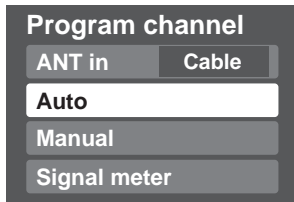

■ Press to exit from menu screen



## 5 Set

■ To reset the settings of setup menu

- ① Select "Reset" in Setup menu (3) and press OK
- ② Input your 4-digit password with number buttons
- ③ Select "YES" on the confirmation screen and press OK

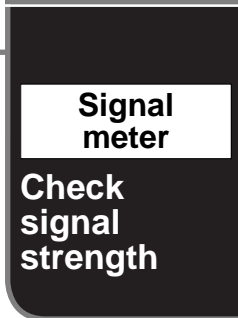
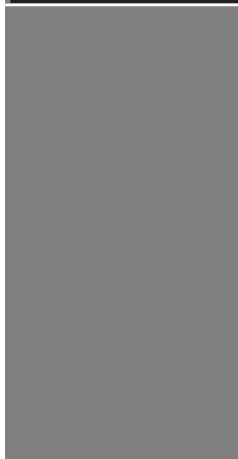
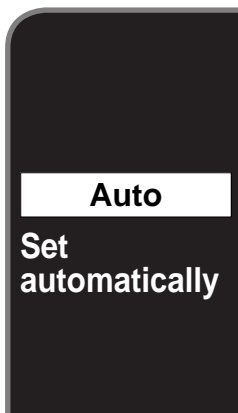

Automatically searches and adds active channels to memory.

① **Select “ANT in”** → Select Cable or Antenna (p. 19)

② **Select “Auto”**

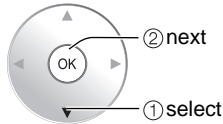
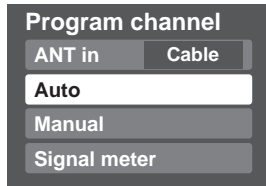

③ **Select scanning mode** (p. 19)

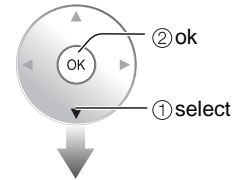
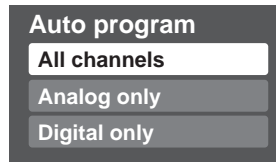

Settings are made automatically

- After completing the setting, select “Apply”. (see below ⑤).
- All previously saved channels are erased.

Use this procedure when changing setting of receiving channels or changing the channel display. Also, use to add or skip channels from channel list manually.

① **Select “Edit”**

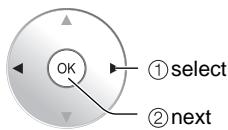
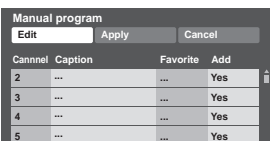

② **Select the item to be edited**

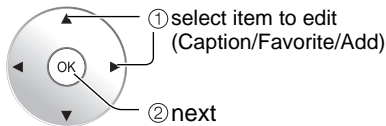
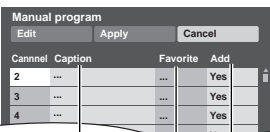

- **Caption:** Changes the station identifier
- **Favorite:** Registers channel to Favorite List
- **Add:** Adds or skips channels

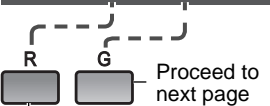

Go back to previous page

③ **Edit**

● **Caption**

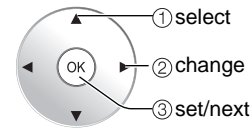
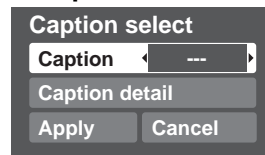

**Caption**

Select the station identifier

**Caption detail**

Rename (maximum 7 characters available)

● **Favorite**

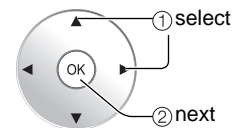
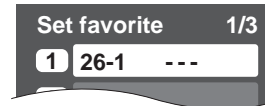

**Set favorite**

Select the number

● **Add**

Press OK to select “Yes (add)” or “No (skip)”



④ **Move cursor to channel number**

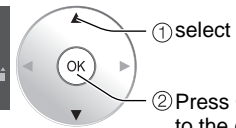
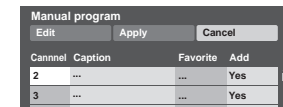

⑤ **Select “Apply”**

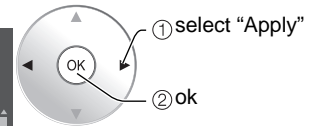
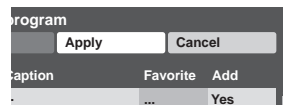

**To cancel the Edit**

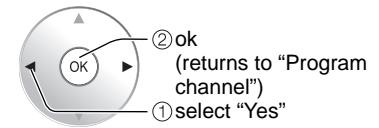
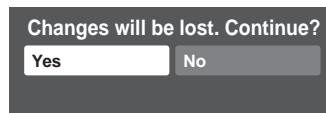
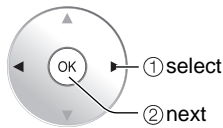
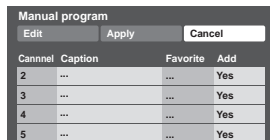

Check the signal strength if interference is found or freezing occurs on a digital image.

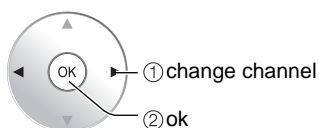
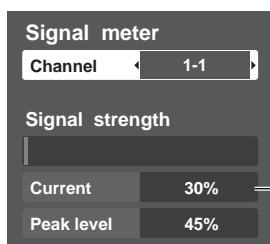

Signal intensity

- If the signal is weak, check the antenna. If no problem is found, consult your local dealer.

**Note**

- Not available if “Cable” is selected in “ANT in” (see above).
- Effective only for digital antenna channels.

● If “Lock” (p. 34) is activated and “Program channel” is selected, “Enter password.” will be displayed.

# Input Labels/Monitor Out/

**1** Display menu

**2** Select "Setup"

**3** Select "External devices" or "CC"

**4** (External devices) Select "Input labels" or "Monitor out"

**5** Set

■ Press to exit from menu screen  
EXIT

**Input labels**

Display labels of external devices

**Monitor out**

Stop output of the picture and audio

**CC**

Display Closed Caption

# Closed Caption

Devices connected to external input terminals can be labeled for easier identification during input selection. (In selecting input mode from p. 24 ②)

## ■ Select the terminal and label of the external equipment

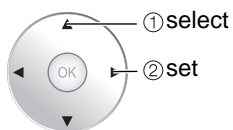
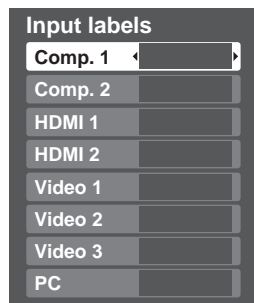

- Terminals: Comp. 1-2/HDMI 1-2/Video 1-3/PC
- Label: SKIP\*/VCR/DVD/CABLE/DBS/PVR/GAME/AUX/[BLANK] (for PC terminal, only SKIP and [BLANK] are available)

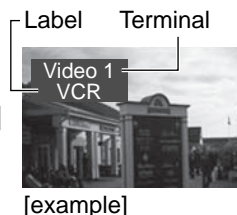

\* If "SKIP" is selected, the TV/VIDEO button press will skip its input.

To prevent howling and image oscillation, stops output of the pictures and audio specified in this menu. (p. 30)

## ■ Select the terminal and set "Off"

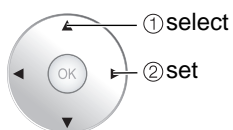
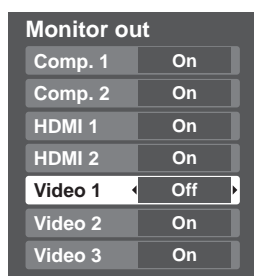

- Select "Off" to stop output of picture and audio. (Video 1/Video 2/Video 3)
- Comp. 1/Comp. 2/HDMI 1/HDMI 2 cannot output video signals regardless of "Monitor out" setting. When equipment (STB, DVD, etc.) is connected to HDMI, COMPONENT or PC terminals, only audio signals can be obtained. From the output terminals, no video signals can be passed.

The television includes a built-in decoder that is capable of providing a text display of the audio. The program being viewed must be transmitting Closed Caption (CC) information. (p. 50)

## ■ Select the item and set

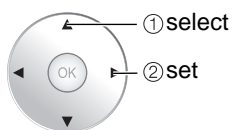
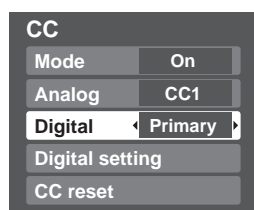

- Mode** Select "On" (when not using, select "Off").
- Analog** (Choose the Closed Caption service of Analog broadcasting.)
  - CC1-4: Information related to pictures (Appears at bottom of screen)
  - T1-4: Textual information (Appears over entire screen)

- The settings in "Analog" or "Digital" depend on the broadcaster.

- Digital** (The Digital Closed Caption menu lets you configure the way you choose to view the digital captioning.)

Select the setting.

- "Primary", "Second.", "Service 3", "Service 4", "Service 5", "Service 6"

## ■ To make more in-depth display settings in digital programs

- ① Select "Digital setting" and press OK
- ② Select the item and set

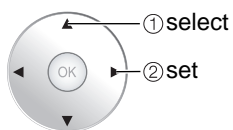
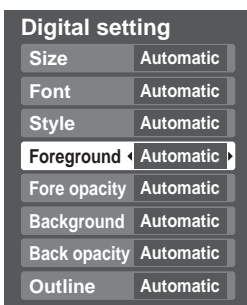

- Size: Text size
- Font: Text font
- Style: Text style (Raised, Depressed, etc.)
- Foreground: Color of text
- Fore opacity: Opacity of text
- Background: Color of text box
- Back opacity: Opacity of text box
- Outline: Outline color of text (Identify the setting options on the screen.)

## ■ To reset the settings

Select "CC reset" and press OK

# Using Timer

The TV can automatically turn On/Off at the designated date and time.

- The Clock must be set before On time/Off time settings. (p. 18)
- The “Sleep” timer and “On / Off timer” will not function if “Auto power on” (p. 30) is set.



## 1 Display menu



## 2 Select “Timer”

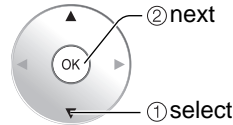
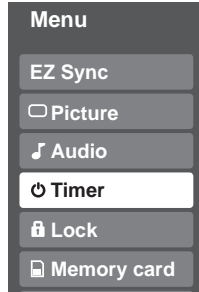

## 3 Select the timer to set

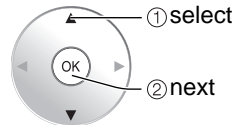
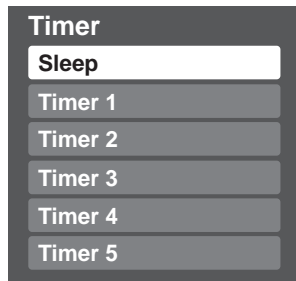

- Sleep** Turns Off automatically
- Timer 1** Turns On/Off automatically (5 timers can be set.)
- Timer 5**

### ■ Press to exit from menu screen

EXIT



### ■ Press to return to the previous screen

RETURN



## 4 Set the timer

### ■ To set “Sleep” (Off Timer)

Set to shut the unit off after a pre-selected amount of time.

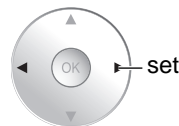

- 0/30/60/90 (minutes)

### ■ To set “Timer 1-5” (On/Off Timer)

Select the item and set

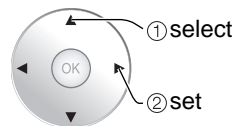
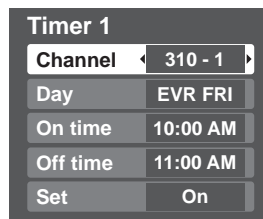

- Channel** Select the channel
- Day** Select the day  
SUN/MON/TUE/WED/THU/FRI/SAT (displays the nearest future date)  
MON-FRI/SAT-SUN/DAILY/EVR SUN/EVR MON/  
EVR TUE/EVR WED/EVR THU/EVR FRI/ EVR SAT

- On time** The time to turn On
- Off time** The time to turn Off
- Set** Timer setting (On/Off)

### Note

- The TV automatically turns Off after 90 minutes when turned On by the Timer. This operation will be cancelled if the Off time is selected or if a key is pressed.



# Operating Peripheral Equipment

You can operate other manufacturers' equipment using this TV's remote control.

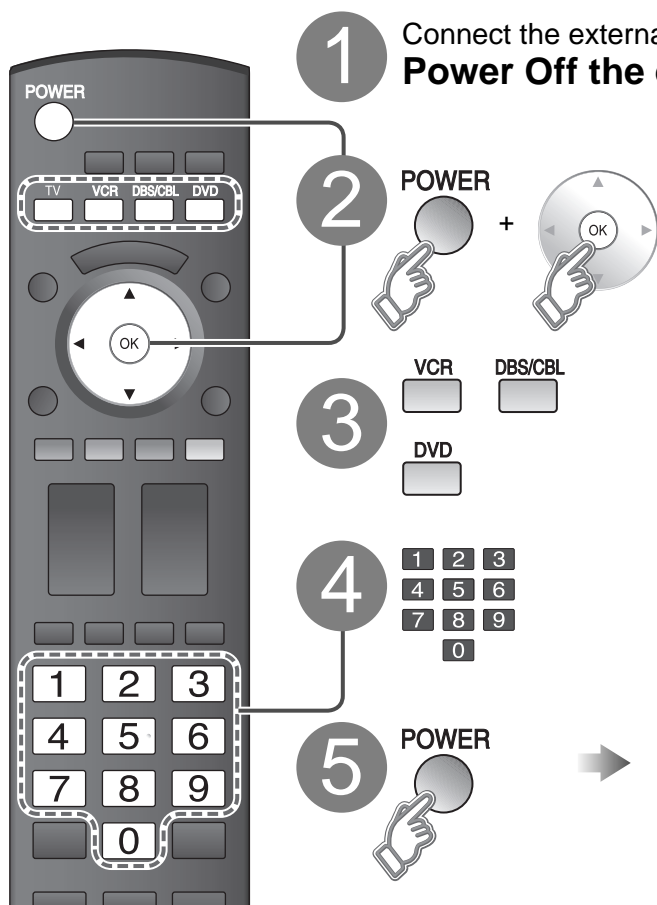

**1** Connect the external equipment to the TV and **Power Off the external equipment**

**2** **Press both buttons simultaneously for more than 3 seconds.**

- Release the buttons when the equipment selection buttons start flashing.

**3** **Select the equipment**

with the equipment selection button

- The selected button remains lit (other buttons are not lit).

**4** **Input the equipment's 4-digit remote control code** (p. 45-47)

**5** **Operate the equipment with the remote control** (p. 44)

- The external equipment turns On.

■ **Press to return to the TV mode**



### Caution

- Registration will fail if the wrong code is input or it takes more than 30 seconds to register.

■ **If the equipment does not operate with the remote control**

- When your equipment has a single code
  - ➔ Input the remote control code again
- When your equipment has multiple codes
  - ➔ Change the code with ④ above and test again

## To find a code not listed in the code list

This procedure searches all codes and is called the "sequence method."

① **After step ③ above, change the code and test**



➔ Operate the equipment with the remote control (p. 44)

- Repeat until the code is found
- It may take many attempts before the correct code is found

② **When the correct code is found**

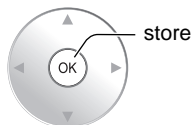

# Recommended AV Connections

These diagrams show our recommendations for how to connect the TV unit to your various equipment. For other connections, consult the instructions for each piece of equipment and the specifications (p. 56). For additional assistance, please visit our website at: [www.panasonic.com](http://www.panasonic.com) [www.panasonic.ca](http://www.panasonic.ca)

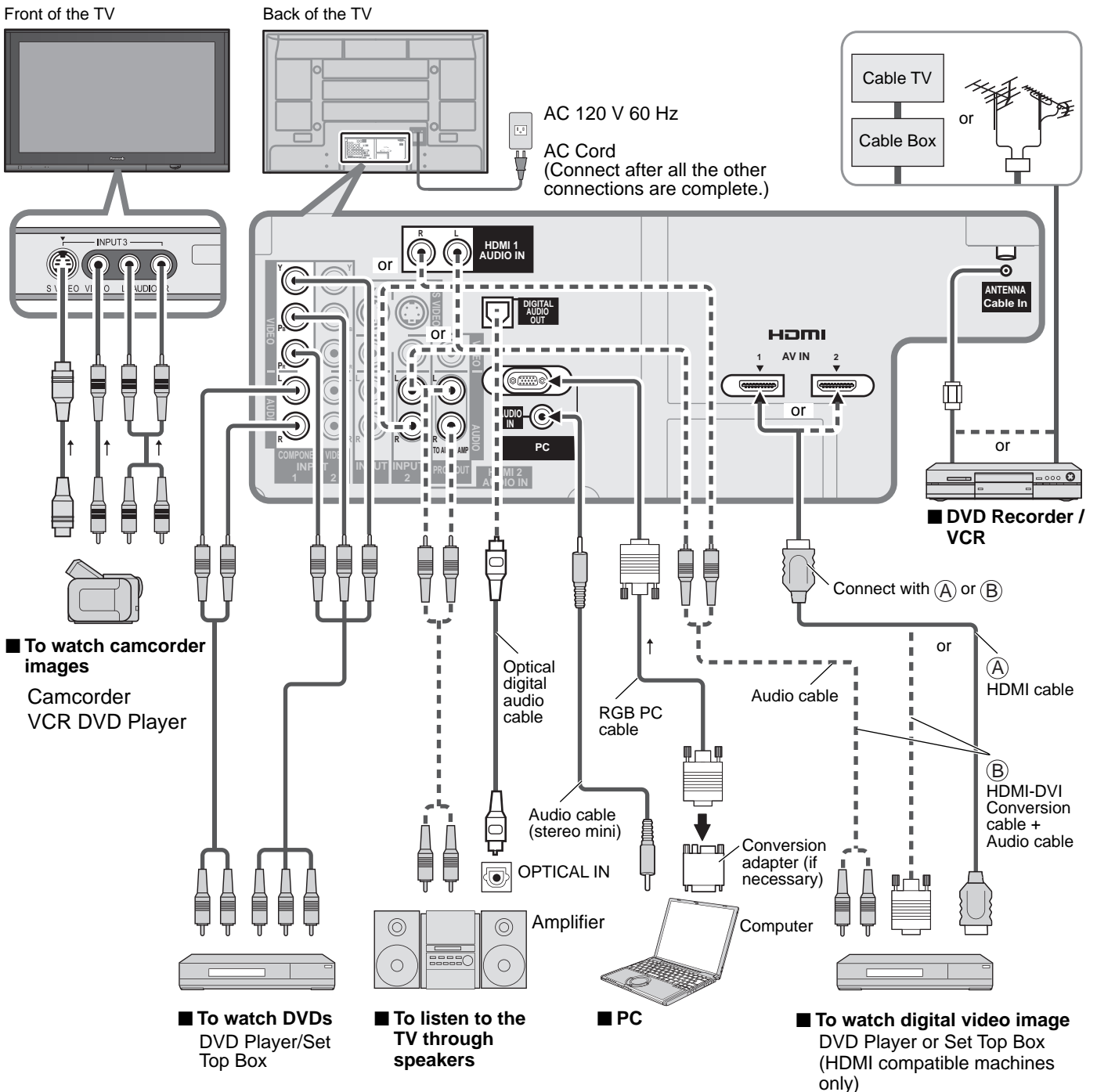

## Note

- The picture and audio input signals connected to a terminal specified in "Monitor out" (p. 38) cannot be output from "PROG OUT" terminals. However, audio output can be obtained from "DIGITAL AUDIO OUT" terminal.
- To prevent howling and image oscillation, set the "Monitor out" setting when connecting the VCR with loop-connection. (p. 30, 38)
- When equipment (STB, DVD, etc.) is connected to HDMI, COMPONENT or PC, terminals, only audio signals can be obtained. From the output terminals, no video signals can be passed.
- When receiving digital channel signals, all digital formats are down-converted to composite NTSC video to be output through the PROG OUT terminals.

Follow the connection diagrams below for HDAVI control of a single AV piece of equipment such as a Panasonic DIGA-DVD recorder, RAM theater, or Player theater system. Refer to page 32-33 for Setup Menu settings and additional control information.

● Optional HDMI and/or optical cables are not provided.

If connection (or setting) of equipment compatible with HDAVI control is changed, switch the power of this unit Off then On again while the power of all equipment is On (so that the unit can correctly recognize the connected equipment) and check that DIGA, RAM theater, and Player theater playback operate.

**Note**

● HDMI 1 is recommended.

When connecting to HDMI 2, set the input mode to HDMI 2 (p. 24) initially before connecting to HDMI 2. After connection, confirm the HDMI control functions (p. 32-33).

**■ Connecting this unit to the DIGA, RAM theater, or Player theater**

● For DIGA: Connect with HDMI cable

● For RAM theater and Player theater: Connect with the HDMI and audio cables.

If audio cable is not connected, you cannot listen to the TV program through the theater system.

**■ Connecting this unit to a DVD recorder and AV amp**

When using an “EZ Sync” audio-video amplifier and a compatible DIGA recorder, use a daisy chain connection as shown below.

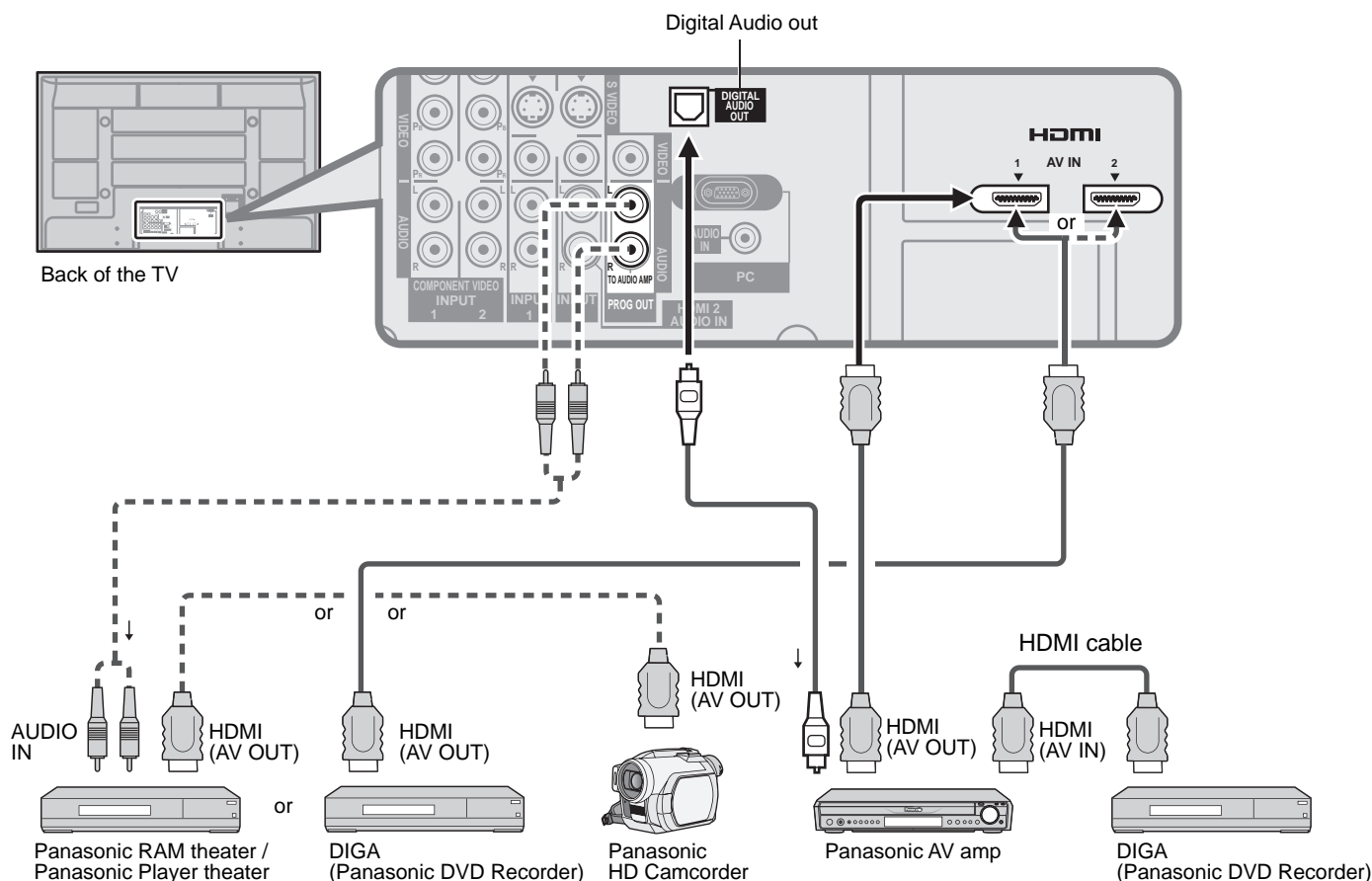

- One AV amp and one DIGA recorder can be operated with this unit.
- Be sure to connect the AV amp between this unit and the DIGA recorder.

**■ Setting of this unit after connection**

After making connections as shown above, set “EZ Sync” (under “EZ Sync setting”) to “On” using the Setup menu. (p. 32-33).

**Note**

- Individual HDMI equipment may require additional menu settings specific to each model. Please refer to their respective operating instruction manuals.
- When audio from other equipment connected to this unit via HDMI is output using “DIGITAL AUDIO OUT” of this unit, the system switches to 2CH audio. (When connecting to an AV amp via HDMI, you can enjoy higher sound quality.)

# Remote Control Operation/Code List

The following explains how to operate external devices with the remote control.



























- Register the remote control codes (p. 41) if you want to operate an external device from another manufacturer. (p. 45-47)

## Note

- Operation may not be possible depending on the available memory size of the remote control.  
This remote control is not designed to cover operation of all functions of all models.

## Remote Control Operation List

This chart defines which keys are operational after programming (if needed) while in the selected remote control mode, CABLE, DBS, VCR, or DVD.

KEY NAME	VCR MODE	DBS/CBL MODE		DVD MODE
		(DBS)	(CBL)	
 POWER	Power	Power	Power	Power
 SAP	—	LIST	LIST	DVD AUDIO
 TV VIDEO	TV Input Switch	TV Input Switch	TV Input Switch	TV Input Switch
 MENU	—	Menu	Menu	Functions
 EXIT	—	Exit	Exit	—
	—	Up/Down/Left/Right	Up/Down/Right/Left	Up/Down/Right/Left
	—	Select	Select	Enter
 SUB MENU	—	Guide	Guide	Sub Menu
 RETURN	—	PPV/VOD	PPV/VOD	Return
 R	—	Red	A	Red
 G	—	Green	B	Green
 B	—	Blue	C	Blue
 Y	—	Yellow	D	Yellow
	Channel Up/Down	Channel Up/Down	Channel Up/Down	Channel Up/Down
	TV Volume Up/Down	TV Volume Up/Down	TV Volume Up/Down	TV Volume Up/Down
 ASPECT	—	Aspect	Aspect	—
 FAVORITE	—	Favorite	Favorite	Direct Navigator
 RECALL	Onscreen Display	Info	Info/Display/OSD	Onscreen Display
 MUTE	TV Mute	TV Mute	TV Mute	TV Mute
	0-9	0-9	0-9	0-9
 R-TUNE	—	Last Channel	Last Channel	Drive Select
 PROG-	—	Sub Channel	Music	PROG (Sub Channel)
	—	Page Down/Up	Page Down/Up	Skip Reverse/Forward
 TV/VCR	TV/VCR Switch	TV/DBS Switch	TV/CBL Switch	—
	Rewind/Fast Forward	Rewind/Fast Forward	Rewind/Fast Forward	Reverse/Forward
 REC	VCR Record	PVR Record *1	PVR Record *1	Record
 STOP	Stop	Stop	Stop	Stop
PAUSE	Pause	Pause	Pause	Pause
PLAY	Play	Play	Play	Play

\*1: Combination type

## Remote Control Code List

Cable Converter ( <sup>DBS/CBL</sup> )							
Brand	Code	Brand	Code	Brand	Code	Brand	Code
A-Mark	0008, 0144	Gibralter	0003	Penney	0000	Tocom	0012
ABC	0003, 0008, 0237	GMI	0883	Philips	0317, 1305	Torx	0003
Accuphase	0003	GoldStar	0144	Pioneer	0144, 0533, 0877, 1877	Toshiba	0000
Acorn	0237	Hamlin	0009, 0273	Prism	0012	Tristar	0883
Action	0237	Hitachi	0003, 0008, 0009	Pulsar	0000	United Cable	0003, 0276
Active	0237	Insight	0476, 0810	Quasar	0000	US Electronics	0003, 0008, 0276
Americast	0899	Jerrold	0003, 0012, 0276, 0476, 0810	RadioShack	0883	V2	0883
Archer	0237	Memorex	0000	RCA	1256	Videoway	0000
BCC	0276	Mitsubishi	0003	Regal	0273, 0276, 0279	Viewmaster	0883
Bell South	0899	Motorola	0276, 0476, 0810, 1254, 1376	Runco	0000	Vision	0883
British Telecom	0003	Multitech	0883	Samsung	0003, 0144	Vortex View	0883
Century	0008	Nova Vision	0008	Scientific Atlanta	0000, 0003, 0008, 0012, 0237, 0477, 0877, 1877	Zenith	0000, 0525, 0899
Clearmaster	0883	Novaplex	0008	Sony	1006		
ClearMax	0883	NSC	0012	Sprucer	0144		
Cool Box	0883	Pace	0008, 0237, 0877, 1877	Starcom	0003		
Coolmax	0883	Panasonic	0000, 0008, 0107, 0144	Supercable	0276		
Director	0476	Paragon	0000, 0008, 0525	Supermax	0883		
Fosgate	0276			Thomson	1256		
GE	0144						
General Instrument	0003, 0012, 0276, 0476, 0810						

Cable/PVR Combination ( <sup>DBS/CBL</sup> )							
Americast	0899	Motorola	0810, 1376	Scientific Atlanta	0877, 1877	Zenith	0899
General Instrument	0810	Pace	0237, 1877	Sony	1006		
Jerrold	0810	Pioneer	0877, 1877	Supercable	0276		
		RCA	1256	Thomson	1256		

Satellite Receiver ( <sup>DBS/CBL</sup> )							
Bell ExpressVu	0775	GE	0392, 0566	Motorola	0856, 0869	Samsung	1108, 1109, 1142, 1276, 1377, 1442, 1609
Chaparral	0216	General Instrument	0869	Netsat	0099	SKY	0856, 0099
Crossdigital	1109	GOI	0775, 1775	Next Level	0869	Sony	0639, 1639, 1640
DirecTV	0099, 0247, 0392, 0566, 0639, 0724, 0749, 0819, 1076, 1108, 1109, 1142, 1377, 1392, 1414, 1442, 1609, 1639, 1640, 1749, 1856	Hitachi	0749, 0819, 1250	Optimus	0724	Star Choice	0869
Dish Network System	0775, 1005, 1505, 1775	Houston	0775	Panasonic	0247, 0701, 1786	Star Trak	0869
Dishpro	0775, 1005, 1505, 1775	HTS	0775, 1775	Paysat	0724	Thomson	0392, 0566
EchoStar	0775, 1005, 1505, 1775	Hughes Network Systems	0749, 1142, 1442, 1749	Philips	0099, 0722, 0724, 0749, 0775, 0819, 1076, 1142, 1442, 1749	Tivo	1142, 1442
Expressvu	0775, 1775	Innova	0099	Pioneer	1142, 1442	Toshiba	0749, 0790, 0819, 1285, 1749
Funai	1377	Jerrold	0869	Primestar	0869	UltimateTV	1392, 1640
		JVC	0775, 1775	Proscan	0392, 0566	Uniden	0724, 0722
		LG	1414	RadioShack	0566, 0775, 0869	Voom	0869
		Magnavox	0722, 0724	RCA	0392, 0566, 0775, 1142, 1392, 1442	Zenith	0856, 1856
		McIntosh	0869				
		Memorex	0724				
		Mitsubishi	0749				

DBS/PVR Combination (S) ( <sup>DBS/CBL</sup> )							
DirecTV	0099, 0392, 0639, 1076, 1142, 1377, 1392, 1442, 1640	Dishpro	0775, 1505	Motorola	0869	Sony	0639, 1640
Dish Network System	0775, 1505	EchoStar	0775, 1505	Philips	1142, 1442	Star Choice	0869
		Expressvu	0775	Proscan	0392		
		Hughes Network Systems	1142, 1442	RCA	1392		
				Samsung	1442		

VCR ( <sup>VCR</sup> )							
A-Mark	0000, 0037, 0240, 0278	Asha	0240	Carver	0035, 0081	Curtis Mathes	0000, 0035, 0060, 0162, 0240, 0278, 0432, 1035
ABS	1972	Astra	0035, 0240	CCE	0278	Cybernex	0240
Admiral	0039, 0047, 0048, 0060, 0209, 0479	Audiovox	0037, 0038, 0278	Cineral	0278	CyberPower	1972
Adventura	0000, 0037, 0240	Avis	0000	Citizen	0000, 0035, 0037, 0209, 0240, 0278, 0479, 1278	Daewoo	0037, 0045, 0278, 1278
Aiko	0278	Beaumarck	0240	Classic	0037	Daytron	0037, 0278
Aiwa	0000, 0037	Bell & Howell	0000, 0035, 0039, 0048, 0479	Colortyme	0035, 0045, 0060, 0278	Dell	1972
Alba	0209, 0278	Broksonic	0002, 0121, 0209, 0479, 1479	Colt	0000	Denon	0042, 0081
Alienware	1972	Calix	0037	Craig	0037, 0047, 0240	DirecTV	0739
Allegro	0039	Candle	0037, 0038	Criterion	0000	Dual	0000
America Action	0278	Canon	0035	Crosley	0000, 0035, 0081	Durabrand	0038, 0039
American High	0035, 0081	Capehart	0002	Crown	0278	Dynatech	0000, 0240
Amstrad	0000	Carrera	0240				

# Remote Control Operation/Code List (Continued)

## Remote Control Code List

VCR ( )							
Brand	Code	Brand	Code	Brand	Code	Brand	Code
Electrohome	0000, 0037, 0043, 0060, 0209, 0240	Magnin	0240	Quasar	0002, 0035, 0162, 1035	Thomson	0060
Electrosonic	0037	Marantz	0035, 0038, 0081	RadioShack	0000, 0035, 0037, 0047, 0048, 0162, 0240	Tisonic	0278
Emerald	0121, 0184	Marta	0037	Radix	0037	Tivo	0618, 0636, 0739, 1996
Emerex	0032	Matsui	0037, 0209	Randex	0037	TMK	0000, 0240
Emerson	0000, 0002, 0037, 0043, 0121, 0184, 0209, 0240, 0278, 0479, 1278, 1479	Matsushita	0035, 0162, 0081	RCA	0000, 0035, 0042, 0045, 0048, 0060, 0240, 0807, 0880, 1035, 1060	TNIX	0037
Fisher	0000, 0039, 0047	Media Center PC	1972	Realistic	0000, 0035, 0037, 0047, 0048, 0121, 0162, 0240, 0278	Tocom	0240
Fuji	0033, 0035	MEI	0035	ReplayTV	0614, 0616	Toshiba	0000, 0043, 0045, 0209, 0240, 0845, 1008, 1145, 1972, 1996
Fujitsu	0000	Memorex	0000, 0035, 0037, 0039, 0162, 0047, 0048, 0209, 0240, 0278, 0479, 1237	Ricavision	1972	Tosonic	0278
Funai	0000, 0037, 0278	Metz	0037	Runco	0039	Totevision	0037, 0240
Garrard	0000	MGA	0043, 0060, 0240	Samsung	0000, 0038, 0045, 0060, 0240, 0432, 0739, 1014	Touch	1972
Gateway	1972	MGN Technology	0240	Samtron	0240	Trix	0037
GE	0000, 0035, 0048, 0060, 0240, 0807, 1035, 1060	Microsoft	1972	Sanky	0039, 0048	Ultra	0045, 0278
Gemini	0060	Midland	0240	Sansui	0000, 0002, 0067, 0209, 0240, 0479, 1479	Unitech	0240
Genexxa	0000, 0037, 0278	Mind	1972	Sanyo	0000, 0047, 0240, 0479	Vector	0045
Go Video	0240, 0432, 0614	Minolta	0042	Scott	0043, 0045, 0184, 0121	Vector Research	0038, 0184
GoldStar	0000, 0035, 0037, 0038, 0039, 0278, 1237	Mitsubishi	0000, 0042, 0043, 0047, 0048, 0060, 0067, 0807	Sears	0000, 0033, 0035, 0037, 0039, 0042, 0043, 0045, 0047, 0048, 0060, 0067, 0162, 0209, 1237	Victor	0067
Goodmans	0000, 0037, 0081, 0278	Motorola	0035, 0048	Sharp	0048, 0047, 0032, 0000, 0807	Video Concepts	0045
Gradiente	0000	MTC	0000, 0240	Shintom	0000, 0039, 0240	Videomagic	0037
Granada	0042, 0081	MTX	0000	Shogun	0240	Videosonic	0000, 0240
Grundig	0081	Multitech	0000, 0039	Siemens	0037	Viewsonic	1972
Harley Davidson	0000	NAD	0240	Signature	0000, 0035, 0037, 0048, 0060, 0479	Villain	0000
Harman/Kardon	0038, 0081	NEC	0038, 0067	Singer	0037, 0240	Voodoo	1972
Hewlett Packard	1972	Nikko	0037, 0278	Sonic Blue	0614, 0616	Wards	0000, 0060, 0033, 0035, 0037, 0038, 0042, 0043, 0045, 0047, 0048, 0081, 0240, 0479
HI-Q	0000, 0035, 0047	Nikkodo	0037, 0278	Sony	0000, 0032, 0033, 0035, 0047, 0067, 0636, 1232, 1972	White Westinghouse	0000, 0209, 0278, 0479
Hitachi	0000, 0035, 0037, 0042, 0045, 0089	Nishi	0240	Soundmaster	0000	World	0002, 0209, 0479
Howard Computers	1972	Niveus Media	1972	Stack 9	1972	XR-1000	0000, 0035, 0240
HP	1972	Noblex	0240	STS	0042	Yamaha	0038
Hughes Network Systems	0042, 0739	Northgate	1972	SV2000	0000	Zenith	0000, 0033, 0037, 0039, 0209, 0278, 0479, 1479
Humax	0739	Olympus	0035, 0162	SVA	0000	ZT Group	1972
Hush	1972	Optimus	0000, 0035, 0037, 0047, 0048, 0162, 0240, 0432, 1062	Sylvania	0000, 0035, 0043, 0081, 1781		
HYTEK	0000, 0047	Orion	0000, 0002, 0121, 0184, 0209, 0240, 0278, 0479, 1479	Symphonic	0000, 0002, 0240		
iBUYPOWER	1972	Panama	0035	Systemax	1972		
ITT Nokia	0240	Panasonic	0000, 0035, 0162, 0225, 0614, 0616, 1035, 1062, 1244	Tagar Systems	1972		
Janeil	0240	Penney	0000, 0035, 0037, 0038, 0042, 0047, 0067, 0081, 0162, 0240, 1035, 1237	Tandy	0000		
Jensen	0067	Pentax	0042	Tatung	0000, 0048, 0067, 0081		
JVC	0067	Philco	0000, 0035, 0081, 0209, 0479	Teac	0000, 0067		
KEC	0037, 0278	Philips	0000, 0035, 0048, 0045, 0081, 0162, 0209, 0616, 0618, 0739	Technics	0000, 0035, 0037, 0162		
Kenwood	0038, 0067	Pilot	0037	Teknika	0000, 0035, 0037		
Kodak	0035, 0037	Pioneer	0042, 0067, 0081, 0162	Telecorder	0240		
KTV	0000	Polk Audio	0081	Tevion	0479		
LG	0037, 0038, 0240	Portland	0278	Thomas	0000, 0002		
Linksys	1972	Profitronic	0240				
Lloyd's	0000, 0038, 0240	Proscan	0060, 1060				
Loewe	0081	Protec	0000				
Logik	0000, 0240	Pulsar	0039, 0240, 0278				
Lumatron	0278	Pulser	0240				
LXI	0000, 0037, 0042, 0067	Quartz	0035, 0047				
M Electronic	0240						
Magnasonic	0000, 0037, 0240, 0278, 1278						
Magnavox	0000, 0035, 0037, 0039, 0048, 0081, 0240, 0618, 1781						

**DBS/PVR Combination (V) (  )**

Brand	Code	Brand	Code	Brand	Code	Brand	Code
Hughes Network Systems	0739	Philips	0739				
		Samsung	0739				

**PVR (V) (  )**

ABS	1972	Hughes Network Systems	0739	Northgate	1972	Tagar Systems	1972
Alienware	1972			Panasonic	0616	Tivo	0618, 0636, 0739
CyberPower	1972	Humax	0739	Philips	0618, 0739	Toshiba	1008, 1972, 1996
Dell	1972	Hush	1972	RCA	0880	Touch	1972
DirecTV	0739	iBUYPOWER	1972	ReplayTV	0614, 0616	Viewsonic	1972
Gateway	1972	Linksys	1972	Samsung	0739	Voodoo	1972
Hewlett Packard	1972	Media Center PC	1972	Sonic Blue	0614, 0616	ZT Group	1972
Howard Computers	1972	Microsoft	1972	Sony	0636, 1972		
		Mind	1972	Stack 9	1972		
HP	1972	Niveus Media	1972	Systemax	1972		

**DVD (  )**

3D LAB	0503, 0539	Funai	0675, 1268	Minato	0752	Samsung	0490, 0573, 0744, 0820, 0899, 1044, 1075
Aiwa	0641	GE	0522, 0815	Mintek	0839		
Akai	0695, 0899	Go Video	0573, 0741, 0744, 0869, 1044, 1075	Mitsubishi	1521, 0521	Sansui	0695
Alba	0672			NAD	0591, 0741	Sanyo	0675, 0695
Alco	0790	GoldStar	0741, 0869	NEC	0785, 0869	Schwaiger	0752
Allegro	0869	Goodmans	0790	Onkyo	0503, 0627, 0792	Sharp	0630, 0675, 0752, 1256
Apex Digital	0533, 0672, 1020, 1056, 1061	Gradiente	0490, 0651	Optimus	0571		
		Grundig	0539	Oritron	0651		
Arrgo	1023	Harman/Kardon	0582	Palsonic	0672	Shinsonic	0533, 0839
Audiovox	0790	Hitachi	0573, 0664	Panasonic	0503, 0490, 0571, 0703, 1362, 1462, 1490, 1762, 2006, 2016, 2026, 1779	Slim Art	0784
Blue Parade	0571	Hiteker	0672			Sonic Blue	0573, 0869
Blue Sky	0695	Insignia	1268	Philips	0503, 0539, 0646, 0675, 1267, 1354	Sony	0533, 0864, 1033, 1431, 1533
Brandt	0651	Integra	0571, 0627			Sylvania	0675, 1268
Broksonic	0695	JMB	0695	Pioneer	0525, 0571, 0631	Symphonic	0675, 1268
California Audio Labs	0490	JVC	0558, 0623, 0867, 1164	Polaroid	1020, 1061	Teac	0571, 0790
		Kawasaki	0790	Polk Audio	0539	Technics	0490, 0703
Celestial	1020	Kenwood	0490, 0534	Presidian	0675	Tevion	0651
Centrex	0672	KLH	0790, 1020	Proceed	0672	Theta Digital	0571
CineVision	0869	Kloss	0533	Proscan	0522	Thomson	0522
Clairtone	0571	Koss	0651, 1061	Qwestar	0651	Toshiba	0503, 0539, 0573, 0695, 1045, 1154
Creative	0503, 0539	Lasonic	0627	Radionette	0741	Universum	0591
CyberHome	0816, 0874, 1023, 1129	Lecson	1533	RadioShack	0571	Urban Concepts	0503, 0539
		LG	0591, 0741, 0869	RCA	0522, 0571, 0790, 0822, 1022, 1132	US Logic	0839
Daewoo	0784, 0869, 1172	LiteOn	1058			Venturer	0790
Denon	0490, 0634	Loewe	0741	Realistic	0571	Xbox	0522
Digitrex	0672	Magnasonic	0651, 0675	Reoc	0752	Yamaha	0490, 0539, 0545
Disney	0675	Magnavox	0503, 0539, 0646, 0675, 1268	Rio	0869	Zenith	0503, 0591, 0741, 0869
Dual	0675	Marantz	0503, 0539, 0675	Rotel	0623		
DVD2000	0521	McIntosh	1533	Saba	0651	Zeus	0784
Emerson	0591, 0675, 1268	Medion	0651	Sampo	0752		
Enterprise	0591	Memorex	0695				
Entivo	0503, 0539	Microsoft	0522				
ESA	1268						
Firstline	0651						

**DVD-Recorder (Y) (  )**

Apex Digital	1056	LG	0741	Pioneer	0631	Sylvania	0675
CyberHome	1129	Magnavox	0646, 0675	RCA	0522	Zenith	0741
Funai	0675	Panasonic	0490, 2006, 2016, 2026	Samsung	0490		
Go Video	0741			Sharp	0675		
JVC	1164	Philips	0646	Sony	1033, 1431		

# Ratings List for Lock

“V-chip” technology enables you to lock channels or shows according to standard ratings set by the entertainment industry. (p. 35)

## ■ U.S. MOVIE RATINGS (MPAA)

NR	NO RATING (NOT RATED) AND NA (NOT APPLICABLE) PROGRAMS. Movie has not been rated or rating does not apply.
G	GENERAL AUDIENCES. All ages admitted.
PG	PARENTAL GUIDANCE SUGGESTED. Some material may not be suitable for children.
PG-13	PARENTS STRONGLY CAUTIONED. Some material may be inappropriate for children under 13.
R	RESTRICTED. Under 17 requires accompanying parent or adult guardian.
NC-17	NO ONE 17 AND UNDER ADMITTED.
X	ADULTS ONLY.

## ■ U.S. TV PROGRAMS RATINGS (U. S. TV)

Age-based Group	Age-based Ratings	Possible Content Selections	Description
NR (Not Rated)	TV-NR	<ul style="list-style-type: none"> <li>● Viewable</li> <li>● Blocked</li> </ul>	Not Rated.
Youth	TV-Y	<ul style="list-style-type: none"> <li>● Viewable</li> <li>● Blocked</li> </ul>	All children. The themes and elements in this program are specifically designed for a very young audience, including children from ages 2-6.
	TV-Y7	<ul style="list-style-type: none"> <li>● FV Blocked</li> <li>● Viewable</li> <li>● Blocked</li> </ul>	Directed to older children. Themes and elements in this program may include mild physical or comedic violence, or may frighten children under the age of 7.
Guidance	TV-G	<ul style="list-style-type: none"> <li>● Viewable</li> <li>● Blocked</li> </ul>	General audience. It contains little or no violence, no strong language, and little or no sexual dialogue or situations.
	TV-PG	<ul style="list-style-type: none"> <li>● D,L,S,V (all selected)</li> <li>● Any combination of D, L, S, V</li> </ul>	Parental guidance suggested. The program may contain infrequent coarse language, limited violence, some suggestive sexual dialogue and situations.
	TV-14	<ul style="list-style-type: none"> <li>● D,L,S,V (all selected)</li> <li>● Any combination of D, L, S, V</li> </ul>	Parents strongly cautioned. This program may contain sophisticated themes, sexual content, strong language and more intense violence.
	TV-MA	<ul style="list-style-type: none"> <li>● L,S,V (all selected)</li> <li>● Any combination of L, S, V</li> </ul>	Mature audiences only. This program may contain mature themes, profane language, graphic violence, and explicit sexual content.

FV: Fantasy/Cartoon Violence. V: Violence S: Sex L: Offensive Language D: Dialogue with sexual content.

## ■ CANADIAN ENGLISH RATINGS (C. E. L. R.)

E	Exempt - Exempt programming includes: news, sports, documentaries and other information programming, talk shows, music videos, and variety programming.
C	Programming intended for children under age 8. No offensive language, nudity or sexual content.
C8+	Programming generally considered acceptable for children 8 years and over. No profanity, nudity or sexual content.
G	General programming, suitable for all audiences.
PG	Parental Guidance suggested. Some material may not be suitable for children.
14+	Programming contains themes or content which may not be suitable for viewers under the age of 14. Parents are strongly cautioned to exercise discretion in permitting viewing by pre-teens and early teens.
18+	18+ years old. Programming restricted to adults. Contains constant violence or scenes of extreme violence.

## ■ CANADIAN FRENCH RATINGS (C. F. L. R.)

E	Exempt - Exempt programming.
G	General - Programming intended for audience of all ages. Contains no violence, or the violence content is minimal or is depicted appropriately.
8 ans+	8+ General - Not recommended for young children. Programming intended for a broad audience but contains light or occasional violence. Adult supervision recommended.
13 ans+	Programming may not be suitable for children under the age of 13 - Contains either a few violent scenes or one or more sufficiently violent scenes to affect them. Adult supervision strongly suggested.
16 ans+	Programming may not be suitable for children under the age of 16 - Contains frequent scenes of violence or intense violence.
18 ans+	Programming restricted to adults. Contains constant violence or scenes of extreme violence.

### Caution

● The V-Chip system that is used in this set is capable of blocking “NR” programs (non rated, not applicable and none) as per FCC Rules Section 15.120(e)(2). If the option of blocking “NR” programs is chosen “unexpected and possibly confusing results may occur, and you may not receive emergency bulletins or any of the following types of programming:”

- Emergency Bulletins (Such as EAS messages, weather warnings and others)
- Locally originated programming • News • Political • Public Service Announcements • Religious • Sports • Weather



# Maintenance

**First, unplug the Power cord plug from the wall outlet.**

## Display panel

The front of the display panel has been specially treated. Wipe the panel surface gently using only a cleaning cloth or a soft, lint-free cloth.

- If the surface is particularly dirty, soak a soft, lint-free cloth in diluted neutral detergent (1 part detergent diluted by 100 times the amount of water) and then wring the cloth to remove excess liquid. Use this cloth to wipe the surface of the display panel, then wipe it evenly with a dry cloth of the same type until the surface is dry.
- Do not scratch or hit the surface of the panel with fingernails or other hard objects. Furthermore, avoid contact with volatile substances such as insect sprays, solvents, and thinner; otherwise, the quality of the surface may be adversely affected.

## Cabinet

If the cabinet becomes dirty, wipe it with a soft, dry cloth.

- If the cabinet is particularly dirty, soak the cloth in a weak detergent solution and then wring the cloth dry. Use this cloth to wipe the cabinet and then wipe it dry with a dry cloth.
- Do not allow any detergent to come into direct contact with the surface of the Plasma TV. If water droplets get inside the unit, operating problems may result.
- Avoid contact with volatile substances such as insect sprays, solvents, and thinner; otherwise, the quality of the cabinet surface may be adversely affected or the coating may peel off. Furthermore, do not leave it for long periods in contact with articles made from rubber or PVC.

## Pedestal

- **Cleaning**  
Wipe the surfaces with a soft, dry cloth. If the unit is particularly dirty, clean it using a cloth soaked with water to which a small amount of neutral detergent has been added and then wipe with a dry cloth. Do not use products such as solvents, thinner, or household wax for cleaning, as they can damage the surface coating. (If using a chemically-treated cloth, follow the instructions supplied with the cloth.)
- Do not attach sticky tape or labels, as they can make the surface of the pedestal dirty. Do not allow long-term contact with rubber, vinyl products, or the like. (Doing so will cause deterioration.)

# Technical Information

## Closed Caption (CC)

- For viewing Closed Caption of digital broadcasting, set the aspect ratio to FULL.  
(If viewing with H-FILL, JUST, ZOOM or 4:3, characters will be cut off.)
- The Closed Caption is not displayed when you use HDMI connection.
- If analog connected equipment is used for displaying or recording, Closed Caption (CC) should be set On/Off on the connected equipment.  
The CC mode setting of the TV will not affect the analog input.  
If a digital program is being output in analog format, the CC data will also be output in analog format.  
If digital connected equipment is used for input, CC should be set On on either the connected equipment or the TV.  
If CC is set On on both the connected equipment and the TV, captions from each unit will overlap.

## Aspect Ratio

Lets you choose the aspect depending on the format of the received signal and your preference. (p. 21)  
(e.g.: in case of 4:3 image)

### ● FULL

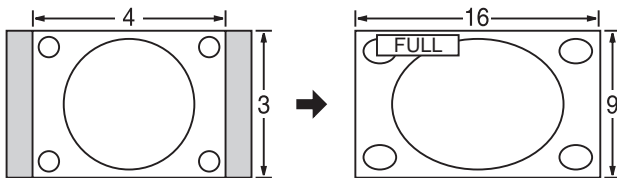

Enlarges the 4:3 image horizontally to the screen's side edges.  
(Recommended for anamorphic picture)

### ● JUST

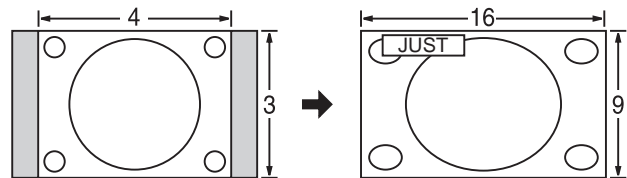

Stretches to justify the 4:3 image to the four corners of the screen.  
(Recommended for normal TV broadcast)

### ● H-FILL

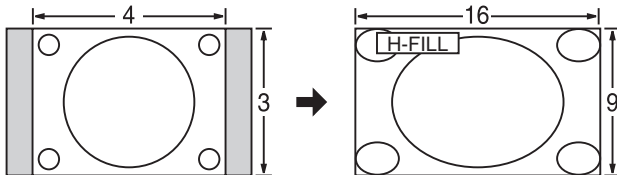

Enlarges the 4:3 image horizontally to the screen's side edges.  
The side edges of the image are cut off.

### ● 4:3

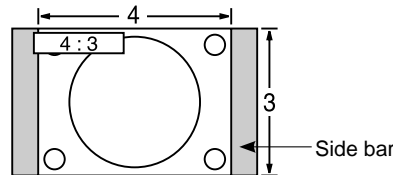

Standard  
(Note that "Image retention" of the side bar may occur from displaying it for a long time.)

### ● ZOOM

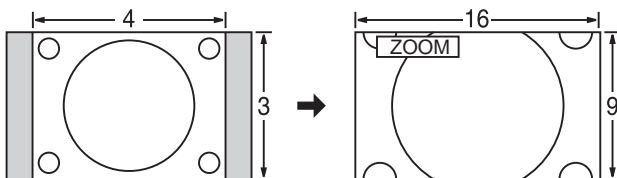

Enlarges the 4:3 image to the entire screen.  
(Recommended for Letter Box)

### Note

- 480i (4:3), 480i (16:9), 480p (4:3), 480p (16:9):  
FULL, JUST, 4:3 or ZOOM
- 1080p / 1080i / 720p:  
FULL, H-FILL, JUST, 4:3 or ZOOM
- When the signal is 720p/1080i/1080p, the aspect mode automatically defaults to Full after turning off the TV, after changing input mode, or after changed signal resolution other than 720p/1080i/1080p.

### ● Zoom adjust

Vertical image position and size can be adjusted in "ZOOM".

- ① Select "Zoom adjust" on the "Picture" menu. (p. 28-29)
- ② V-position: Vertical position adjustment



- ③ V-size: Vertical size adjustment

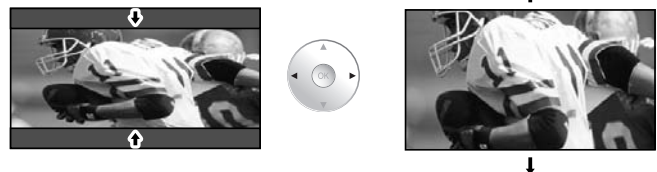

- To reset the aspect ratio →  (OK)

## Data format for SD Card browsing

Photo:	Still images recorded with digital still cameras compatible with JPEG files of DCF* and EXIF** standards
Data format:	Baseline JPEG (Sub-sampling: 4:4:4, 4:2:2 or 4:2:0)
Max. number of files:	9,999
Image resolution:	160 x 120 to 10,000,000

\* DCF (Design rule for camera file system): A Japan Electronics and Information Technology Industries Association's standard

\*\* EXIF (Exchangeable Image File Format)

### Caution

- A JPEG image modified with a PC may not be displayed.
- Partly degraded files might be displayed at a reduced resolution.

### Note

- Folder structure viewed in PC

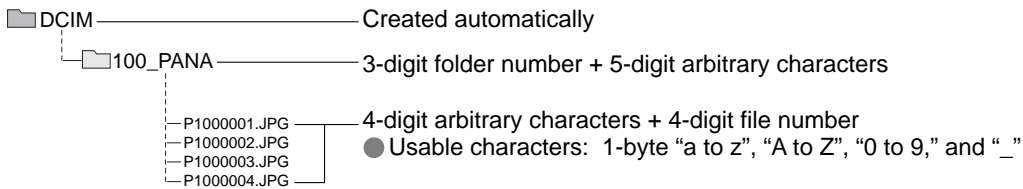

- The folder and file names may be different depending on the digital camera used.
- For the suitable SD Memory Cards, please confirm the latest information on the following website.  
<http://panasonic.co.jp/pavc/global/cs> (This site is in English only)

## SD Card warning messages

Message	Meaning
Is memory card in?	● The card is not inserted.
No file	● The card has no data or this type of data is not supported.
Cannot read file	<ul style="list-style-type: none"> <li>● The file is broken or unreadable.</li> <li>● The TV does not support the format.</li> </ul>

## GalleryPlayer warning messages

Cannot display image due to incorrect ID data.	<ul style="list-style-type: none"> <li>● There is a problem with your TV decoder.</li> <li>● If this message appears, please contact Panasonic Service Center for assistance. Refer to page 57, 59 (Limited Warranty), page 58 (Customer Services Directory)</li> </ul>
Cannot display image on SD card.	● There is a problem with the data. Check the data inside the SD card.

## Cautions in handling SD Card:

- Do not remove the card while the unit is accessing data (this can damage card or unit).
- Do not touch the terminals on the back of the card.
- Do not subject the card to a high pressure or impact.
- Insert the card in the correct direction (otherwise, card may be damaged).
- Electrical interference, static electricity, or erroneous operation may damage the data or card.
- Back up the recorded data at regular intervals in case of deteriorated or damaged data or erratic operation of the unit. (Panasonic is not liable for any deterioration or damage of recorded data.)

## DIGITAL AUDIO OUT terminals

You can enjoy your home theater by connecting a Dolby Digital (5.1 channel) decoder and "Multi Channel" amplifier to the DIGITAL AUDIO OUT terminals.

### Caution

- Depending on your DVD player and DVD-Audio software the copyright protection function may operate and disable optical output.
- External speakers cannot be connected directly to PROG OUT terminals.
- When an ATSC channel is selected, the output from the DIGITAL AUDIO OUT jack will be Dolby Digital. When an NTSC channel is selected, the output will be PCM.

# Technical Information (Continued)

## EZ Sync™ “HDAVI Control™”

HDMI connections to some Panasonic equipment allow you to interface automatically. (p. 32)

- This function may not work normally depending on the equipment condition.
- The equipment can be operated by other remote controls with this function on even if TV is in Standby mode.
- Image or sound may not be available for the first few seconds when the playback starts.
- Image or sound may not be available for the first few seconds when Input mode is switched.
- Volume function will be displayed when adjusting the volume of the equipment.
- If you connect the same kind of equipment at once (for example: one DIGA to HDMI 1 / another DIGA to HDMI 2), EZ Sync™ is available for the terminal with the smaller number.
- If you connect the equipment that has “HDAVI Control 2” function to the TV with HDMI cable, the sound from DIGITAL AUDIO OUT terminal can be output as multi channel surround.
- “HDAVI Control 2” is the newest standard (current as of February, 2007) for Panasonic’s HDAVI Control compatible equipment. This standard is compatible with Panasonic’s conventional HDAVI equipment.

## HDMI connection

HDMI (high-definition multimedia interface) allows you to enjoy high-definition digital images and high-quality sound by connecting the TV unit and the devices.

HDMI-compatible equipment (\*1) with an HDMI or DVI output terminal, such as a set-top box or a DVD player, can be connected to the HDMI connector using an HDMI compliant (fully wired) cable.

- HDMI is the world’s first complete digital consumer AV interface complying with a non-compression standard.
- If the external equipment has only a DVI output, connect to the HDMI terminal via a DVI to HDMI adapter cable (\*2).
- When the DVI to HDMI adapter cable is used, connect the audio cable to the audio input terminal.
- Audio settings can be made on the “HDMI 1 in” or “HDMI 2 in” menu screen. (p. 28)  
Applicable audio signal sampling frequencies (L.PCM): 48 kHz, 44.1 kHz, 32 kHz

(\*1): The HDMI logo is displayed on an HDMI-compliant device.

(\*2): Enquire at your local digital equipment retailer shop.

### Caution

- Use with a PC is not assumed.
- All signals are reformatted before being displayed on the screen.
- If the connected device has an aspect adjustment function, set the aspect ratio to “16:9”.
- These HDMI connectors are “type A”.
- These HDMI connectors are compatible with HDCP (High-Bandwidth Digital Content Protection) copyright protection.
- A device having no digital output terminal may be connected to the input terminal of either “COMPONENT”, “S VIDEO”, or “VIDEO” to receive analog signals.
- The HDMI input terminal can be used with only the following image signals: 480i, 480p, 720p, 1080i and 1080p.  
Match the output setting of the digital device.
- For details of the applicable HDMI signals, see p. 53.

## Side Bar

Do not display a picture in 4:3 mode for an extended period, as this can cause “Image retention” to remain on either or both sides of the display field.

To reduce the risk of such “Image retention”, change the brightness of the side bars.

- The side bar may flash (alternate black/white) depending on the picture. Using Cinema mode will reduce such flashing (See below).

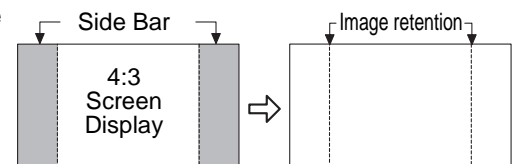

## Picture mode

- Vivid (default): Provides enhanced picture contrast and sharpness for viewing in a well-lit room.
- Standard: Recommended for normal viewing conditions with subdued room lighting.
- Cinema: For watching movies in a darkened room. It provides a soft, film-like picture.
- Custom (Photo): Customizes each item according to your taste.  
Photo is displayed in JPEG menu.

## Input signal that can be displayed

\* Mark: Applicable input signal for Component (Y, Pb, Pr), HDMI and PC

	horizontal frequency (kHz)	vertical frequency (Hz)	COMPONENT	HDMI	PC
525 (480) / 60i	15.73	59.94	*	*	
525 (480) /60p	31.47	59.94	*	*	
750 (720) /60p	45.00	59.94	*	*	
1,125 (1,080) /60i	33.75	59.94	*	*	
1,125 (1,080) /60p	67.43	59.94		*	
1,125 (1,080) /60p	67.50	60.00		*	
640 x 400 @70	31.47	70.08			*
640 x 480 @60	31.47	59.94			*
Macintosh13" (640 x 480)	35.00	66.67			*
640 x 480 @75	37.50	75.00			*
852 x 480 @60	31.47	59.94			*
800 x 600 @60	37.88	60.32			*
800 x 600 @75	46.88	75.00			*
800 x 600 @85	53.67	85.08			*
Macintosh16" (832 x 624)	49.73	74.55			*
1,024 x 768 @60	48.36	60.00			*
1,024 x 768 @70	56.48	70.07			*
1,024 x 768 @75	60.02	75.03			*
1,024 x 768 @85	68.68	85.00			*
Macintosh 21" (1,152 x 870)	68.68	75.06			*
1,280 x 1,024 @60	63.98	60.02			*
1,366 x 768 @60	48.36	60.00			*

### Note

- Signals other than above may not be displayed properly.
- The above signals are reformatted for optimal viewing on your display.

## PC Input Terminals Connection

- Computer signals which can be input are those with a horizontal scanning frequency of 15 to 110 kHz and vertical scanning frequency of 48 to 120 Hz. (However, the image will not be displayed properly if the signals exceed 1,200 lines.)
- Some PC models cannot be connected to the set.
- There is no need to use an adapter for computers with IBM PC/AT compatible D-sub 15P terminal.
- The maximum resolution: 1,280 x 1,024  
If the display resolution exceeds these maximums, it may not be possible to show fine detail with sufficient clarity.
- Signal Names for D-sub 15P Connector

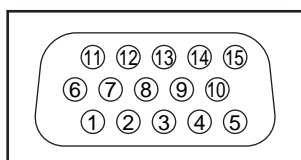

Pin Layout for PC Input Terminal

Pin No.	Signal Name	Pin No.	Signal Name	Pin No.	Signal Name
①	R	⑥	GND (Ground)	⑪	NC (not connected)
②	G	⑦	GND (Ground)	⑫	NC
③	B	⑧	GND (Ground)	⑬	HD/SYNC
④	NC (not connected)	⑨	NC (not connected)	⑭	VD
⑤	GND (Ground)	⑩	GND (Ground)	⑮	NC

# FAQ

Before requesting service or assistance, please follow these simple guides to resolve the problem.  
If the problem still persists, please contact your local Panasonic dealer or Panasonic Service Center for assistance.  
For details (p. 58, 59)  
For additional assistance, please contact us via the website at:  
[www.panasonic.com/contactinfo](http://www.panasonic.com/contactinfo)  
[www.panasonic.ca](http://www.panasonic.ca)

## White spots or shadow images (noise)

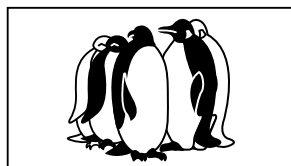

- Check the position, direction, and connection of the aerial.

## Interference or frozen digital channels (intermittent sound)

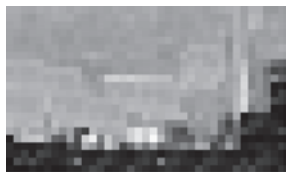

- Change the direction of antenna for digital channels.
- Check "Signal meter" (p. 37). If the signal is weak, check the antenna and consult your local dealer.

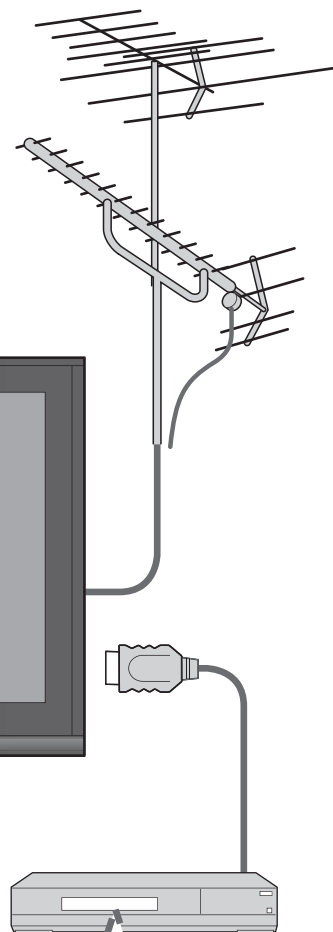
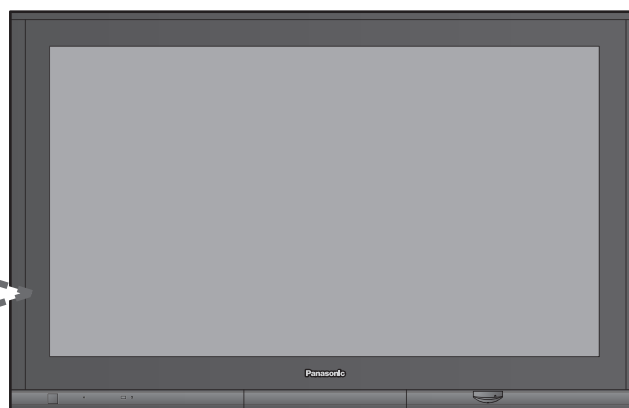

## Pictures from external equipment are distorted when the unit is connected via HDMI

- Is the HDMI cable connected properly? (p. 42-43)
- Turn Off the TV unit and equipment, then turn them On again.
- Check an input signal from the equipment. (p. 53)
- Use equipment compliant with EIA/CEA-861/861B.

## The remote control does not work

- Are the batteries installed correctly? (p. 6)
- Has the battery run down?
- To operate external equipment of other manufacturers, register the remote control codes. (p. 41)



If there is a problem with your TV, please refer to the table below to determine the symptoms, then carry out the suggested check. If this does not solve the problem, please contact your local Panasonic dealer, quoting the model number and serial number (both found on the rear of the TV).

	Problem	Actions
Screen	<b>“Press any key to return” moves on the screen</b>	<ul style="list-style-type: none"> <li>● The function to prevent “Image retention” is activated. (Not a faulty symptom)               <ul style="list-style-type: none"> <li>● The screen saver is activated if the TV unit is not operated for a certain time in SD mode.</li> <li>● “Image retention” (p. 5)</li> </ul> </li> </ul>
	<b>One spot remains dark</b>	<ul style="list-style-type: none"> <li>● A pixel or luminescent spot can occasionally be missing in plasma displays. (Not a faulty symptom)</li> </ul>
	<b>Chaotic image, noisy</b>	<ul style="list-style-type: none"> <li>● Check nearby electrical products (car, motorcycle, fluorescent lamp).</li> </ul>
	<b>No image can be displayed</b>	<ul style="list-style-type: none"> <li>● Check Picture menu (p. 28)</li> </ul>
	<b>Only spots are displayed instead of images</b>	<ul style="list-style-type: none"> <li>● Check the channel settings. (p. 36)</li> <li>● Check the antenna cables.</li> </ul>
	<b>Neither image nor sound is produced</b>	<ul style="list-style-type: none"> <li>● Is the AC power cord plugged into the outlet?</li> <li>● Is the TV unit turned On?</li> <li>● Check Picture menu (p. 28) and volume.</li> <li>● Are the remote control codes correct? (p. 45-47)</li> </ul>
	<b>Black Box appears</b>	<ul style="list-style-type: none"> <li>● Change settings of Closed Caption (CC). (p. 38)</li> </ul>
Sound	<b>No sound is produced</b>	<ul style="list-style-type: none"> <li>● Are the speakers’ cables connected correctly? (p. 42)</li> <li>● Is “Sound Mute” active? (p. 17)</li> <li>● Is the volume set to the minimum?</li> <li>● Is “Speaker output” set to “Off”? (p. 28)</li> <li>● Change “SAP” settings. (p. 20)</li> <li>● Check “HDMI 1 in” or “HDMI 2 in” settings. (p. 28)</li> </ul>
	<b>Sound is unusual</b>	<ul style="list-style-type: none"> <li>● Set “SAP” setting to “Stereo” or “Mono.”</li> <li>● Check the HDMI device connected to the unit.</li> <li>● Set the audio setting of the HDMI device to “Linear PCM.”</li> <li>● If digital sound connection has a problem, select analog sound connection.</li> </ul>
	<b>Whirling sound is heard</b>	<ul style="list-style-type: none"> <li>● The sound is from built-in cooling fan (not a sign of faulty operation).</li> </ul>

# Specifications

		TH-42PZ700U	TH-50PZ700U	TH-58PZ700U
<b>Power Source</b>		AC 120 V, 60 Hz		
<b>Power Consumption</b>	<b>Maximum</b>	580 W	695 W	735 W
	<b>Standby condition</b>	0.2 W	0.2 W	0.2 W
<b>Plasma Display panel</b>	<b>Drive method</b>	AC type		
	<b>Aspect Ratio</b>	16:9		
	<b>Visible screen size (W x H x Diagonal)</b>	42" (Diagonal) 36.2" x 20.4" x 41.6" (922 mm x 518 mm x 1,057 mm)	50" (Diagonal) 43.5" x 24.4" x 49.9" (1,106 mm x 622 mm x 1,269 mm)	58" (Diagonal) 50.5" x 28.4" x 58.0" (1,284 mm x 723 mm x 1,474 mm)
	<b>(No. of pixels)</b>	2,073,600 (1,920 (W) x 1,080 (H)) [5,760 x 1,080 dots]		
<b>Sound</b>	<b>Audio Output</b> Super Slim SP (2.5 W) x 2 Woofer (13 W) x 2			
<b>PC signals</b>		VGA, SVGA, XGA, WXGA, SXGA Horizontal scanning frequency 31 - 69 kHz Vertical scanning frequency 59 - 86 Hz		
<b>Channel Capability (Digital/Analog)</b>		VHF/ UHF: 2 - 69, CATV: 1 - 135		
<b>Operating Conditions</b>		Temperature: 32 °F – 104 °F (0 °C – 40 °C) Humidity: 20 % – 80 % RH (non-condensing)		
<b>Connection Terminals</b>	<b>INPUT 1-3</b>	VIDEO: RCA PIN Type x 1 1.0 V [p-p] (75 Ω) S-VIDEO: Mini DIN 4-pin Y: 1.0 V [p-p] (75 Ω) C: 0.286 V [p-p] (75 Ω) AUDIO L-R: RCA PIN Type x 2 0.5 V [rms]		
	<b>COMPONENT VIDEO INPUT 1-2</b>	Y: 1.0 V [p-p] (including synchronization) PB, PR: ±0.35 V [p-p] AUDIO L-R: RCA PIN Type x 2 0.5 V [rms]		
	<b>HDMI 1-2</b>	TYPE A Connector x 2 ● This TV supports "HDAVI Control 2" function.		
	<b>AUDIO IN</b>	AUDIO L-R: RCA PIN Type x 2 0.5 V [rms]		
	<b>PC</b>	D-SUB 15PIN: R,G,B / 0.7 V [p-p] (75 Ω) HD, VD / 1.0 - 5.0 V [p-p] (high impedance) AUDIO L-R: Stereo Mini Jack (Φ3.5 mm) x 1		
	<b>Card slot</b>	SD CARD slot x 1		
	<b>AV PROG. OUT</b>	VIDEO: RCA PIN Type x 1 1.0 V [p-p] (75 Ω) AUDIO L-R: RCA PIN Type x 2 0.5 V [rms]		
	<b>DIGITAL AUDIO OUT</b>	PCM / Dolby Digital, Fiber Optic		
<b>FEATURES</b>		3D Y/C FILTER CLOSED CAPTION V-Chip BBE VIVA 3D Photo viewer HDAVI Control 2		
<b>Dimensions (W x H x D)</b>	<b>Including pedestal</b>	42.5" x 29.8" x 14.6" (1,077 mm x 755 mm x 369 mm)	49.9" x 33.5" x 14.6" (1,266 mm x 850 mm x 369 mm)	57.3" x 38.2" x 16.5" (1,454 mm x 970 mm x 418 mm)
	<b>TV Set only</b>	42.5" x 27.2" x 5.5" (1,077 mm x 689 mm x 138 mm)	49.9" x 31.6" x 5.5" (1,266 mm x 802 mm x 138 mm)	57.3" x 36.2" x 5.7" (1,454 mm x 918 mm x 144 mm)
<b>Mass</b>	<b>Including pedestal</b>	99.3 lb. (45 kg)	123.5 lb. (56 kg)	165.4 lb. (75 kg)
	<b>TV Set only</b>	83.8 lb. (38 kg)	105.9 lb. (48 kg)	141.1 lb. (64 kg)

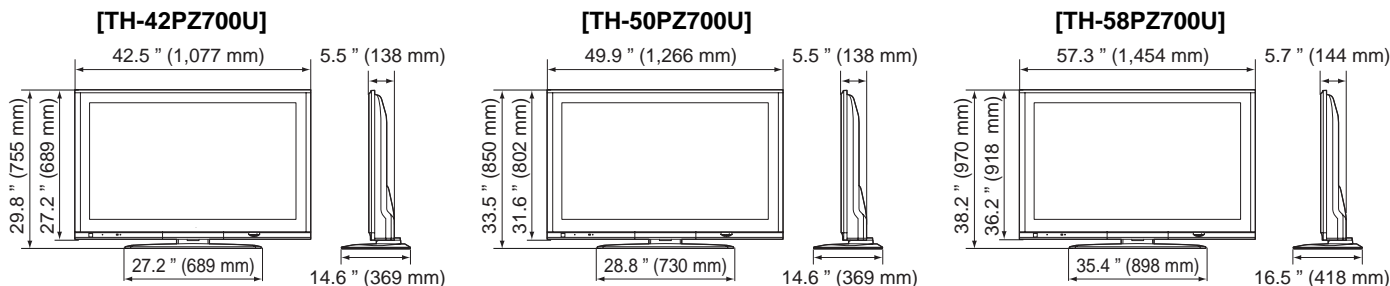

## Note

● Design and Specifications are subject to change without notice. Mass and Dimensions shown are approximate.



# Limited Warranty (for U.S.A.)

PANASONIC CONSUMER ELECTRONICS COMPANY,  
DIVISION OF  
PANASONIC CORPORATION OF NORTH AMERICA  
One Panasonic Way  
Secaucus, New Jersey 07094

PANASONIC SALES COMPANY,  
DIVISION OF  
PANASONIC PUERTO RICO, INC.  
Ave. 65 de Infanteria, Km. 9.5  
San Gabriel Industrial Park  
Carolina, Puerto Rico 00985

## Panasonic Color Television Limited Warranty

### Limited Warranty Coverage

If your product does not work properly because of a defect in materials or workmanship, Panasonic Consumer Electronics Company or Panasonic Puerto Rico, Inc. (collectively referred to as "the warrantor") will, for the length of the period indicated on the chart below, which starts with the date of original purchase ("Limited Warranty period"), at its option either (a) repair your product with new or refurbished parts, or (b) replace it with a new or a refurbished product. The decision to repair or replace will be made by the warrantor.

CATEGORIES	ALL PARTS EXCEPT GLASS PANEL OR CRT	LABOR	GLASS PANEL OR CRT	GLASS PANEL OR CRT LABOR	SERVICE
PLASMA DISPLAY	1 (ONE) YEAR	1 (ONE) YEAR	GLASS PANEL - 2 (TWO) YEARS	1 (ONE) YEAR	IN-HOME OR CARRY-IN

During the "Labor" Limited Warranty period there will be no charge for labor. During the "Parts" Limited Warranty period, there will be no charge for parts.

You must carry-in your product or arrange for in-home service during the Limited Warranty period. If non-rechargeable batteries are included, they are not warranted. This Limited Warranty only applies to products purchased and serviced in the United States or Puerto Rico. This Limited Warranty is extended only to the original purchaser and only covers product purchased as new. A purchase receipt or other proof of the original purchase date is required for Limited Warranty service.

### In-Home or Carry-in Service

For In-Home or Carry-In Service in the United States call 1-888-VIEW-PTV(1-888-843-9788).  
For assistance in Puerto Rico call Panasonic Puerto Rico, Inc. (787)-750-4300 or fax (787)-768-2910.

In-Home service requires clear, complete and easy access to the product by the authorized servicer and does not include removal or re-installation of an installed product. It is possible that certain in-home repairs will not be completed in-home, but will require that the product, or parts of the product, be removed for shop diagnosis and/or repair and then returned.

### Limited Warranty Limits And Exclusions

This Limited Warranty ONLY COVERS failures due to defects in materials or workmanship, and DOES NOT COVER normal wear and tear or cosmetic damage, nor does it cover markings or retained images on the picture tube resulting from viewing fixed images (including, among other things, letterbox pictures on standard 4:3 screen TV's, or non-expanded standard 4:3 pictures on wide screen TV's, or onscreen data in a stationary and fixed location). The Limited Warranty ALSO DOES NOT COVER damages which occurred in shipment, or failures which are caused by products not supplied by the warrantor, or failures which result from accidents, misuse, abuse, neglect, bug infestation, mishandling, misapplication, alteration, faulty installation, set-up adjustments, misadjustment of consumer controls, improper maintenance, power line surge, lightning damage, modification, or commercial use (such as in a hotel, office, restaurant, or other business), rental use of the product, service by anyone other than a Factory Service Center or other Authorized Servicer, or damage that is attributable to acts of God.

**THERE ARE NO EXPRESS WARRANTIES EXCEPT AS LISTED UNDER "LIMITED WARRANTY COVERAGE". THE WARRANTOR IS NOT LIABLE FOR INCIDENTAL OR CONSEQUENTIAL DAMAGES RESULTING FROM THE USE OF THIS PRODUCT, OR ARISING OUT OF ANY BREACH OF THIS LIMITED WARRANTY.** (As examples, this excludes damages for lost time, cost of having someone remove or re-install an installed unit if applicable, or travel to and from the servicer. The items listed are not exclusive, but are for illustration only.) **ALL EXPRESS AND IMPLIED WARRANTIES, INCLUDING THE LIMITED WARRANTY OF MERCHANTABILITY, ARE LIMITED TO THE PERIOD OF THE LIMITED WARRANTY.**

Some states do not allow the exclusion or limitation of incidental or consequential damages, or limitations on how long an implied Limited Warranty lasts, so the exclusions may not apply to you.

This Limited Warranty gives you specific legal rights and you may also have others rights which vary from state to state. If a problem with this product develops during or after the Limited Warranty period, you may contact your dealer or Service Center. If the problem is not handled to your satisfaction, then write to the warrantor's Consumer Affairs Department at the addresses listed for the warrantor.

**PARTS AND SERVICE (INCLUDING COST OF AN IN-HOME SERVICE CALL, WHERE APPLICABLE) WHICH ARE NOT COVERED BY THIS LIMITED WARRANTY ARE YOUR RESPONSIBILITY.**

# Customer Services Directory (for U.S.A.)

## Customer Services Directory

Obtain Product Information and Operating Assistance; locate your nearest Dealer or Service Center; purchase Parts and Accessories; or make Customer Service and Literature requests by visiting our Web Site at:

**<http://www.panasonic.com/consumersupport>**

or, contact us via the web at:

**<http://www.panasonic.com/contactinfo>**

You may also contact us directly at:

1-888-VIEW-PTV (843-9788)

Monday-Friday 9 am-9 pm; Saturday-Sunday 10 am-7 pm, EST.

■ For hearing or speech impaired TTY users, TTY: 1-877-833-8855

## Accessory Purchases

Purchase Parts, Accessories and Instruction Books on line for all Panasonic Products by visiting our Web Site at:

**<http://www.pstc.panasonic.com>**

or, send your request by E-mail to:

**[npcparts@us.panasonic.com](mailto:npcparts@us.panasonic.com)**

You may also contact us directly at:

1-800-332-5368 (Phone) 1-800-237-9080 (Fax Only) (Monday - Friday 9 am to 8 pm, EST.)

Panasonic Service and Technology Company

20421 84th Avenue South,

Kent, WA 98032

(We Accept Visa, MasterCard, Discover Card, American Express, and Personal Checks)

■ For hearing or speech impaired TTY users, TTY: 1-866-605-1277

## Service in Puerto Rico

Panasonic Puerto Rico, Inc.

Ave. 65 de Infantería, Km. 9.5, San Gabriel Industrial Park,

Carolina, Puerto Rico 00985

Phone (787)750-4300, Fax (787)768-2910

# Limited Warranty (for Canada)

Panasonic Canada Inc.

## PANASONIC PRODUCT - LIMITED WARRANTY

Panasonic Canada Inc. warrants this product to be free from defects in material and workmanship and agrees to remedy any such defect for a period as stated below from the date of original purchase.

Plasma TV / Monitor	In-home service	One (1) year, parts (including Plasma Panel) and labour.
LCD TV (26 in & over)	In-home service	One (1) year, parts (including LCD Panel) and labour.
LCD TV (25 in & under)	Carry-in service only	One (1) year, parts (including LCD Panel) and labour.

In-home Service will be carried out only to locations accessible by roads and within 50 km of an authorized Panasonic service facility.

### **LIMITATIONS AND EXCLUSIONS**

This warranty does not apply to products purchased outside Canada or to any product which has been improperly installed, subjected to usage for which the product was not designed, misused or abused, damaged during shipping, or which has been altered or repaired in any way that affects the reliability or detracts from the performance, nor does it cover any product which is used commercially. Dry cell batteries are also excluded from coverage under this warranty.

This warranty is extended to the original end user purchaser only. A purchase receipt or other proof of date of original purchase is required before warranty service is performed.

**THIS EXPRESS, LIMITED WARRANTY IS IN LIEU OF ALL OTHER WARRANTIES, EXPRESS OR IMPLIED, INCLUDING ANY IMPLIED WARRANTIES OF MERCHANTABILITY AND FITNESS FOR A PARTICULAR PURPOSE. IN NO EVENT WILL PANASONIC CANADA INC. BE LIABLE FOR ANY SPECIAL, INDIRECT OR CONSEQUENTIAL DAMAGES.**

In certain instances, some jurisdictions do not allow the exclusion or limitation of incidental or consequential damages, or the exclusion of implied warranties, so the above limitations and exclusions may not be applicable.

In-home service requires clear, complete and easy access to the product by the Authorized Servicentre and does not include removal or re-installation of an installed product. If removal is required to service the product, it will be at the discretion of the Servicentre and in no event will Panasonic Canada Inc. or the Servicentre be liable for any special, indirect or consequential damages.

### **WARRANTY SERVICE**

**For product operation and information assistance**, please contact:

Our Customer Care Centre: Telephone #: (905) 624-5505  
1-800 #: 1-800-561-5505  
Fax #: (905) 238-2360  
Email link: "Customer support" on [www.panasonic.ca](http://www.panasonic.ca)

**FOR PRODUCT REPAIRS**, please locate your nearest Authorized Servicentre at [www.panasonic.ca](http://www.panasonic.ca):

Link: "Servicentres™ locator" under "Customer support"

### **IF YOU SHIP THE PRODUCT TO A SERVICENTRE**

Carefully pack and send prepaid, adequately insured and preferably in the original carton.  
Include details of the defect claimed, and proof of date of original purchase.

**Customer's Record**

The model number and serial number of this product can be found on its back cover. You should note this serial number in the space provided below and retain this book, plus your purchase receipt, as a permanent record of your purchase to aid in identification in the event of theft or loss, and for Warranty Service purposes.

Model Number \_\_\_\_\_

Serial Number \_\_\_\_\_

**Anotación del cliente**

El modelo y el número de serie de este producto se encuentran en su panel posterior. Deberá anotarlos en el espacio provisto a continuación y guardar este manual, más el recibo de su compra, como prueba permanente de su adquisición, para que le sirva de ayuda al identificarlo en el caso de que le sea sustraído o lo pierda, y también para disponer de los servicios que le ofrece la garantía.

Modelo \_\_\_\_\_

Número de serie \_\_\_\_\_

**Panasonic Consumer Electronics  
Company,  
Division of Panasonic Corporation  
of North America**  
One Panasonic Way, Secaucus  
New Jersey 07094 U.S.A.

**Panasonic Puerto Rico, Inc.**  
Ave. 65 de Infantería, Km. 9.5  
San Gabriel Industrial Park  
Carolina, Puerto Rico 00985

**Panasonic Canada Inc.**  
5770 Ambler Drive  
Mississauga, Ontario  
L4W 2T3 CANADA